

Beautifully Traditional

Burlington®

Classically styled bathrooms



Introduction

From the late 1800's into the 1900's, Britain led the way in bathroom design and performance. Burlington bathrooms bring a complete collection of traditional bathroom products for you to create a classical, British bathroom from eras of great design. Our range is extensive and allows you to create a look and feel to suit your personal choice, safe in the knowledge that these are all designed to co-ordinate together perfectly.



CERAMICS

SEE PAGE 2



FURNITURE

SEE PAGE 72



BATHS

SEE PAGE 102



TAPS & BRASSWARE

SEE PAGE 132



SHOWERING

SEE PAGE 154



ACCESSORIES

SEE PAGE 176

Contents

CERAMICS

There are four eras of history reflected in our designs; Classic, Edwardian, Victorian and Contemporary. Within each of these designs there are sizes to suit your bathroom, shower room or cloakroom. A selection of WCs and bidets are available to match your washbasin selection.

OVERVIEW	2
CLASSIC	8
EDWARDIAN & VICTORIAN	24
CONTEMPORARY & STONE	40
WCS	50
CLOAKROOMS	66

FURNITURE

A range of beautifully traditional furniture solutions to add classic style and sophisticated British elegance to your bathroom. Choose from free-standing, either a square or round design, wall-hung or fully-fitted options.

OVERVIEW	72
FREESTANDING	74
WALL HUNG	86
FITTED	90

BATHS

Our range of baths includes grand free-standing baths, roll top baths and standard baths. Roll top baths have a range of matching feet and the Hampton roll top is even designed to fit into a corner, fitting a modest size bathroom.

OVERVIEW	102
DOUBLE ENDED	104
SINGLE ENDED	118
SHOWERING	126

TAPS & BRASSWARE

Burlington taps and mixers bring classic design packed with innovative technology. There are separate taps, one and three piece basin mixers, an Arch fitting and bath fittings with telephone handsets, each with a choice of handles for up to 324 combination2.

OVERVIEW	132
BASIN & BATH	136
SUNDRY	138

SHOWERING

Shower mixers with modern safe thermostatic control are the way forward for controllable showering, and a period enclosure can complete your bathroom.

OVERVIEW	154
SHOWERS & VALVES	156
SHOWER ENCLOSURES	168

ACCESSORIES

The look is complete with stunning chrome plated solid brass accessories. From corner baskets for your shower, to soap dispensers, they provide the perfect finishing touch to your bathroom.

RADIATORS	176
MIRRORS & LIGHTS	180
ACCESSORIES	186

Ceramics

There are a great variety of basin options within the Burlington family. Choose from the simply styled Classic basin in either a round or square design, the Edwardian basin with its subtle angular appearance, again in a round or square design, Victorian with a refined look or Contemporary for a minimal and pared back form. Basins can be available in one, two or three tap hole options and can be used on a variety of styled pedestals; either full, regal, semi-pedestal, washstand or even counter-top options.



...on all sanitaryware
See website for details



The Ceramic Range

Yesterday's design with today's advanced technology

Burlington Bathroom design is governed largely by the washbasin style. Every design is crafted to reflect the specific era in which British sanitaryware rose in fame and was heralded as the best in aesthetic and performance. Burlington's key design themes are represented through Classic, Edwardian, Victorian and Contemporary eras. Every basin is crafted to the highest quality and is full of character and style with various choices in style, size and other options to suit your own individual tastes and requirements.



CLASSIC

The Classic collection from Burlington is beautifully formed, either as a curvaceous round design or a grand square model. This collection also features the invisible overflow, and innovative waste technology see p10 for details.

Pages 08-23



CLOAKROOM

A selection of cloakroom options have been crafted so you can match your chosen style throughout the home. You'll find Edwardian, Victorian and more Classic styled cloakroom basins to achieve a consistent and beautiful look throughout every washroom.

Pages 66-71

Pages 24-33



EDWARDIAN

The Edwardian collection is the ultimate in traditional bathrooms with structured corners and angular designs, the feel is un-apologetic and proud.



VICTORIAN

A delicate and refined range, the simplicity of this ceramic basin is stunning. Available in a medium (56cm) or large (61cm) and a range of pedestal and tap hole options, the versatility of this style allows you to continue the style throughout your home and brings an air of luxury to every room.

Pages 34-39



CONTEMPORARY

As the name suggests, the Contemporary collection is styled on the elegance of past times but with a modern day twist. Simplistic, structured lines form the basis for this striking ceramic collection. Available as full pedestal, semi-pedestal or with a chrome washstand.

Pages 40-43



...on all sanitaryware
See website for details

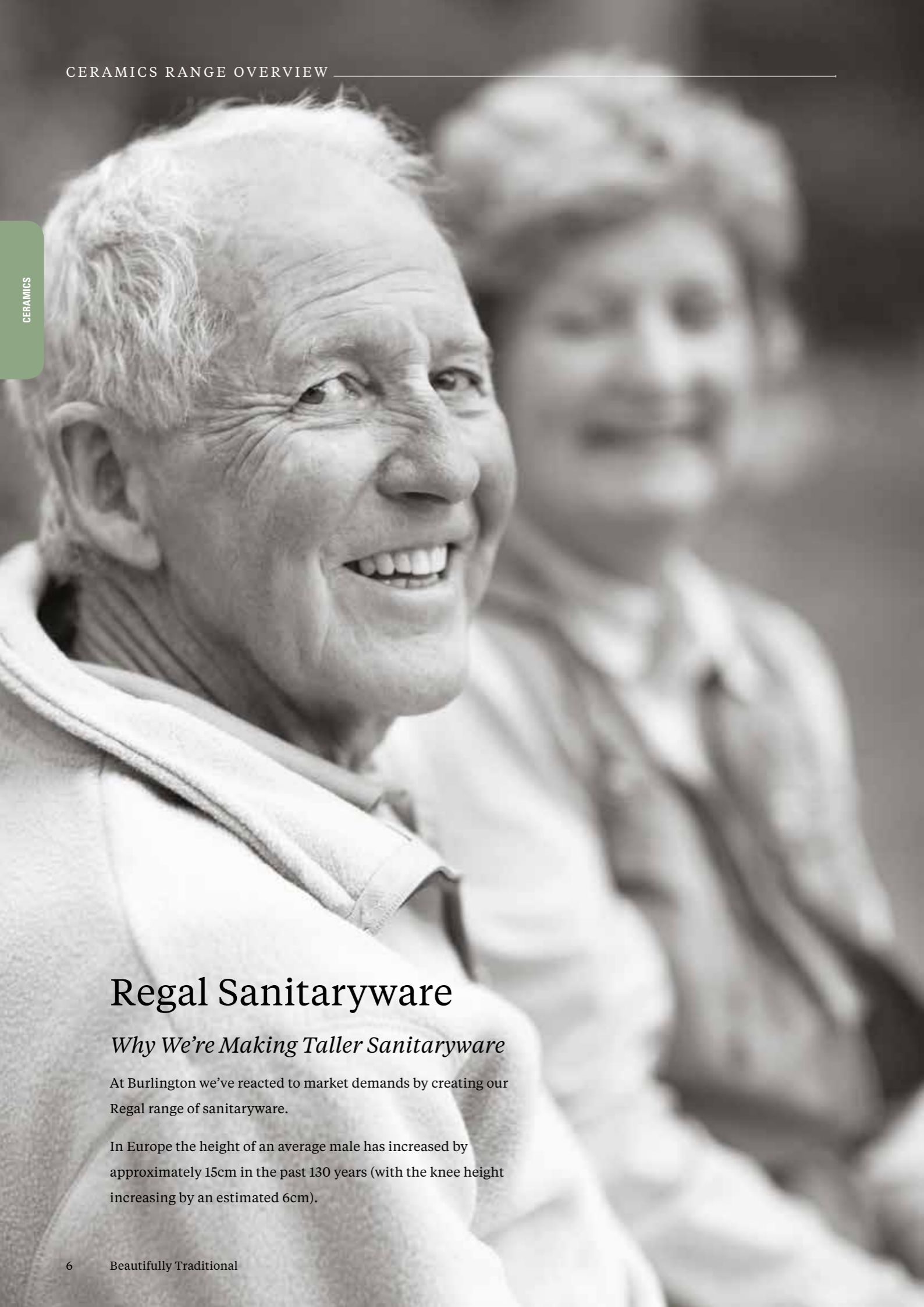

Regal Sanitaryware

Why We're Making Taller Sanitaryware

At Burlington we've reacted to market demands by creating our Regal range of sanitaryware.

In Europe the height of an average male has increased by approximately 15cm in the past 130 years (with the knee height increasing by an estimated 6cm).

EUROPEAN HEIGHT INCREASES

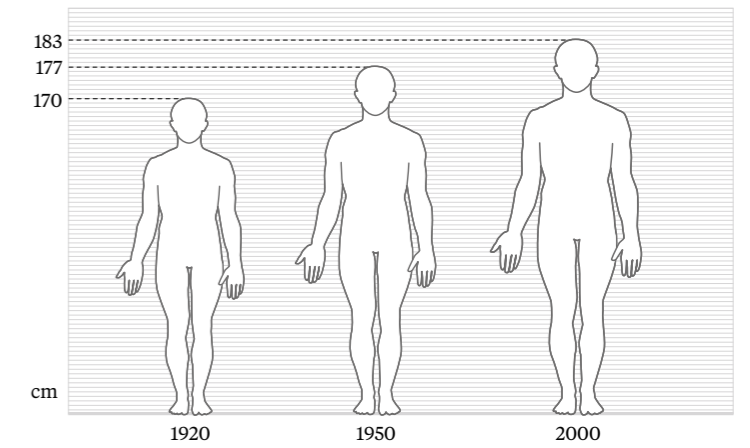

Here at Burlington we've created a range that's 6cm higher than average sanitaryware.

When using a WC the correct seating position is to have a knee angle of approximately 90°. At 48cm high the Regal WCs enable this.

Higher sanitaryware not only helps taller people but it also helps if you're older: It's far easier getting on and off a loo that's 48cm high than one that's 42cm high. The basin height is higher too; reducing the need to arch your back too much.

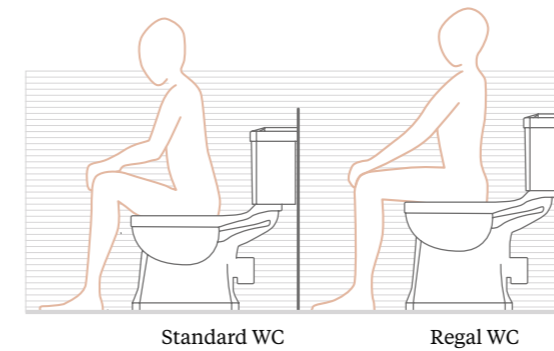

CLOSE COUPLED & LOW LEVEL WCs

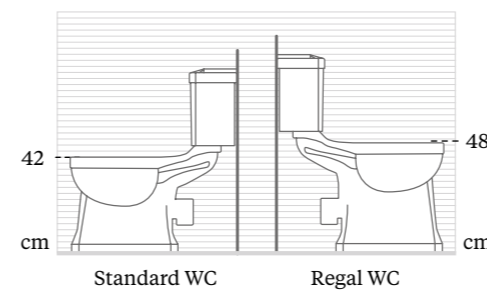

BACK TO WALL WCs

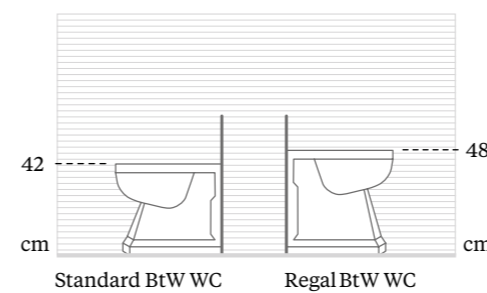

PEDESTAL OPTIONS ↓

Available with the Classic & Classic Round Basins

Burlington Regal pedestals are 6cm higher than the standard pedestals.

	Standard Height	Regal Height
Classic	86cm	92cm
Victorian classic	84cm	90cm
Edwardian classic	84cm	90cm
Contemporary classic	84cm	90cm



WASHSTAND OPTIONS ↓

Available with the Classic, Edwardian, Victorian and Cloakroom

Burlington Regal washstands are 6cm higher than the standard washstand to ensure a more ergonomic use for taller individuals.

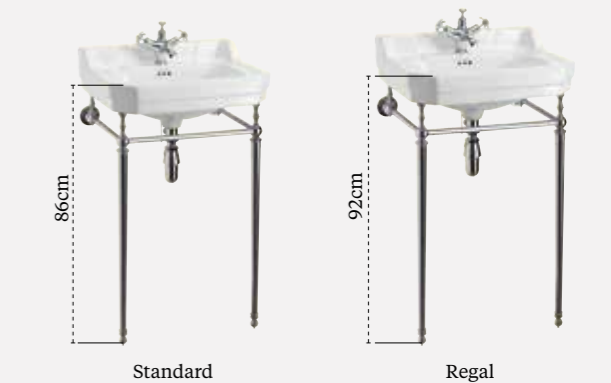

Classic

CERAMICS



Classic Basin with Invisible overflow. See page 20 for more details.

Classic Basin 1TH with Pedestal.



Classic Round 3TH with Regal Pedestal.



The Classic basin collection from Burlington is beautifully formed, either as a grand square design or a curvaceous round model. This collection also features an innovative waste technology. Choose a Classic basin with invisible overflow allowing you to have seamless ceramic without a plug. All Classic basins are available as 1, 2 or 3 tap holes on standard or regal pedestals or a range of washstands and furniture see page 74, 75 & 76 for more details.

CERAMICS



PEDESTAL OPTIONS ↓
Available with the Classic & Classic Round Basins

Burlington Regal pedestals are 6cm higher than the standard pedestal to ensure a more ergonomic use for taller individuals.





CERAMICS

CERAMICS



The Classic round basin has beautiful form with a curvaceous front adding an interesting feature to a simplistic overall appearance. The piece works seamlessly with other classically designed Burlington products such as close-coupled WCs or soft, rounded soaking tubs.

Classic round basin with standard pedestal €462, Claremont 5" basin pillar taps €151, plug & chain basin waste €17, close-coupled WC and cistern with ceramic lever €328 with soft-close mahogany seat €105 (or with chrome handles €116), and ceramic trap €88. Brindley bath and skirt €1053.

See pages 22-23 for technical details on the Classic round basin.

WC FLUSH ←

Design a bathroom to suit your specific needs

View the full range of WCs from page 50 onwards

All Burlington WCs are fitted with box rims, which even though they are harder to manufacture, provide a more accurate flush spread. The cisterns are fitted with dual flush water saving technology.

Pair your beautifully styled Classic round basin with the new round pedestal.
With its elegant form and tasteful detailing, the overall effect is one of refined class.

This page and opposite: Classic round basin with Classic round pedestal €473, Claremont basin 5" pillar taps €151 and plug and chain basin waste €17.

See pages 22-23 for technical details on the Classic round basin.



A grand basin design, the Classic works beautifully in every surrounding to create a vintage inspired bathroom, effortlessly.

Bloomsbury radiator €467 with angled radiator valves €58, Rectangular mirror €233, Classic basin with standard pedestal €526 and Anglesey 3 tap hole basin mixer with pop-up waste €314.

See pages 22-23 for technical details on the Classic basin.

Classic basin 1 tap hole with chrome basin stand €830, Claremont 1 tap hole basin mixer with pop-up waste €239 and traditional basin bottle trap €46.

See pages 22-23 for technical details on the Classic basin.

English Garden

The English garden range sees the Classic style basins brought to life with delicate floral transfers. The new round pedestal is softened with finite moulded detail, exuding class and sophistication.

CERAMICS



CERAMICS

This page top: English garden close-coupled WC with cistern €473 with soft-close seat white €105 and ceramic trap €88 (see page 63). English garden round basin and English garden round pedestal €630 with Claremont 1 tap hole basin mixer with click-clack waste €265.

This page bottom: English garden basin and English garden pedestal €630 with Claremont 1 tap hole basin mixer with central indice and click-clack waste €265.

See page 22 for technical details on the English Garden basins.

CERAMICS



Rectangular mirror €233, Edwardian single elliptical lights €105 each, Classic basin invisible overflow with standard pedestal €526 and invisible overflow waste €163 and bottle trap €46, Claremont 5" basin pillar taps €151, medium-level WC with ceramic cistern lever €560 with soft-close oak seat €105 (or with chrome handles €116) and ceramic trap €88.

CERAMICS



Bloomsbury radiator €467 with angled radiator valves €58, Rectangular mirror €233, Classic basin invisible overflow with standard pedestal €526, Claremont 5" basin pillar taps €151 and invisible overflow waste €163.

See pages 22-23 for technical details on the Classic basin.

Invisible Overflow



On all sanitaryware
See website for details



The benefit of invisible overflow is that the ceramic of the beautiful basins is un-interrupted with no requirement for a plug or external waste. Simply pull the lever up to drain water. Pair with the elegant and beautiful Arch basin mixer allowing you to mix hot and cold water.

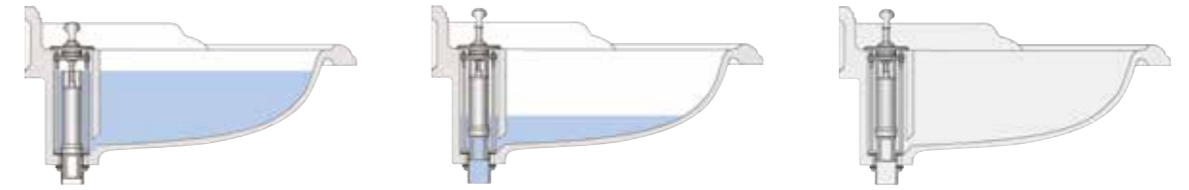

Classic basin invisible overflow & waste
W9 €163

Classic Basins

CLASSIC BASINS

Basin Shapes	Basins				Pedestals*				Chrome Wash Stands				Aluminium Wash Stands (E)	
					Standard (C)		Regal		Standard (D)		Regal			
	Width	Depth	Code	Price	Code	Price	Code	Price	Code	Price	Code	Price	Code	Price
Rectangular (A)	65cm	58cm	B15 z*	€409	P6	€118	P9R	€123	T49A CHR	€422	T49ACHR+T62	€493	T38 h**	€503
Round (B)	65cm	58cm	B17 z*	€409	P6	€118	P9R	€123						

ENGLISH GARDEN CLASSIC BASINS

Basin Shapes	Basins				Pedestals*				Chrome Wash Stands				Aluminium Wash Stands	
					Standard		Regal		Standard		Regal			
	Width	Depth	Code	Price	Code	Price	Code	Price	Code	Price	Code	Price	Code	Price
Rectangular	65cm	58cm	B15D*	€467	-	-	P9RD	€163	T49A CHR	€422	T49ACHR+T62	€493	T38 h**	€503
Round	65cm	58cm	B17D*	€467	-	-	-	-						

* Classic basins are available with 1, 2 or 3 tap holes. To order the correct basin configuration simply remove the 'z' and replace it with 1TH, 2TH or 3TH.

** To order the correct wash stand colour simply remove the 'h' from the product code and replace it with 'ALU' for aluminium, 'BLA' for Black, or 'WHI' for white.

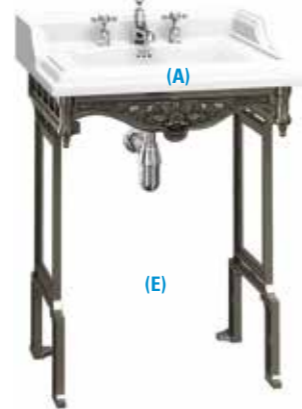

For Classic basins with furniture see pages 76, 77 and 86.



For Classic Invisible Overflow basins with furniture see pages 76, 77 and 86.

Classic Invisible Overflow Basins

CLASSIC INVISIBLE OVERFLOW BASINS

Basin Shapes	Basins			Pedestals*				Chrome Wash Stands				Aluminium Wash Stands (E)		
				Standard (C)		Regal		Standard (D)		Regal				
	Width	Depth	Code	Code	Price	Code	Price	Code	Price	Code	Price	Code	Price	
Rectangular (F)	65cm	58cm	B14***	€409	P6	€118	P9R	€123	T49ACHR	€422	T49ACHR+T62	€493	T38 h**	€503
Round (G)	65cm	58cm	B16***	€409	P6	€118	P9R	€123	-	-	-	-	-	-

** To order the correct wash stand colour simply remove the 'h' from the product code and replace it with 'ALU' for aluminium, 'BLA' for Black, or 'WHI' for white.

*** Classic basins with invisible overflows are only available in two tap hole and must use basin waste W9

Overall heights to the top of the front basin surface:

Classic Basin with Standard Pedestal: 86cm

Classic Basin with Regal Pedestal: 92cm

Classic Basin with wash stand: 88cm

Classic Basin with Regal basin stand: 92cm

Classic Basin with Aluminium wash stand: 89cm



Classic basin invisible overflow & waste W9 **€163**

Edwardian

CERAMICS



Edwardian 61cm basin with standard pedestal €229
and Claremont 3 tap hole basin mixer with pop-up waste €315.
See pages 30-33 for technical details on the Edwardian basins collection.

56cm Edwardian 1TH Basin & Washstand.



The Edwardian collection is the ultimate in traditional bathrooms with structured upstands and angular designs, the feel is un-apologetic and proud. Edwardian basins come in a range of sizes from the Standard 56cm to the Large 61cm and now with the exciting addition of a Grand 80cm basin which will provide an eye catching centrepiece to your period styled bathroom. All are available in one, two or three taphole options and all can be used on the standard pedestal, the Regal pedestal, the semi-pedestal or on a washstand.

There is also a 56cm Edwardian round basin available with one or two tapholes, also suitable for all the pedestal and washstand options. With the strong personality of the upstand back, this basin is true traditional design at its very best.

61cm Edwardian 1TH Basin with Semi-pedestal & Towel Rail.



56cm Edwardian Round 1TH Basin & Regal Pedestal.



56cm Edwardian Round 1TH Basin & Wash Stand



CERAMICS



Edwardian 80cm basin with basin stand €830, Claremont 3 tap hole basin mixer with pop-up waste €315, flat bottomed basin bottle trap €99 and curved mirror €268.

See pages 30-33 for technical details on the Edwardian basin.



Edwardian 80cm basin with standard pedestal €467 and Claremont 3 tap hole basin mixer with pop-up waste €315.



The Edwardian basin is available in a range of sizes and options. Pair with a semi-pedestal combined with a towel rail for the illusion of increased space in smaller bathrooms. The towel rails are available to add to any basin, adding extra functionality.



Edwardian Rectangular Basin

Edwardian 61cm basin with semi-pedestal and towel rail €323, Claremont 1 tap hole basin mixer with click-clack waste €265. Low-level WC slimline cistern with front flush button €456, soft-close oak seat €105 (with chrome handles €116), ceramic trap €88 and WC toilet roll holder €70.

See pages 30-33 for technical details on the Edwardian basin.



Edwardian Rectangular Basins

EDWARDIAN RECTANGULAR BASINS

Basins				Pedestals						Chrome Basin Stands				Towel Rails (D)	
Width	Depth	Code	Price	Standard (B)		Regal		Semi		Standard (C)		Regal		Code	Price
56cm	47cm	B4 z*	€141	P1	€71	P9	€118	P8	€94	T22A CHR	€385	T22ACHR+T62	€445	T1 CHR	€77
61cm (A)	51 cm	B5 z*	€153	P1	€71	P9	€118	P8	€94	T23A CHR	€422	T23ACHR+T62	€482	T3 CHR	€77
80cm	51cm	B18 z*	€350	P6	€118	P9	€118			T50 CHR	€480	T50CHR+T62	€540		

* Edwardian Rectangular Basins are available with 1, 2 or 3 tap holes. To order the correct basin configuration simply remove the 'z' and replace it with 1TH, 2TH or 3TH.



...on all sanitaryware
See website for details



Edwardian Round Basins

EDWARDIAN ROUND BASINS

Basins				Pedestals						Chrome Basin Stands				Towel Rails (D)	
Width	Depth	Code	Price	Standard (B)		Regal		Semi		Standard (C)		Regal		Code	Price
				Code	Price	Code	Price	Code	Price	Code	Price	Code	Price		
56cm (A)	47cm	B6 z*	€164	P1	€77	P9	€118	P8	€94	T24A CHR	€387	T24ACHR+T62	€447	T4 CHR	€116

* Edwardian Round Basins are available with 1 or 2 tap holes. To order the correct basin configuration Simply remove the 'z' and replace it with 1TH or 2TH.

Overall heights to the top of the front basin surface:

Edwardian Basin with Standard Pedestal: 84cm

Edwardian Basin with Regal Pedestal: 90cm

Edwardian Basin with Basin stand: 84cm

Edwardian Basin with Regal basin stand: 90cm



(A)

(A)

(A)



...on all sanitaryware
See website for details



Edwardian round 56cm basin with pedestal €240, Claremont 5" basin pillar taps €151 and plug and chain waste €17. Low-level WC slimline cistern with front flush button €456 with soft-close oak seat €105 (with chrome handles €116) and ceramic trap €88. WC toilet roll holder €70. London round soaking tub €1639 with floor-standing Claremont bath shower mixer €977. Edwardian single elliptical light €105.

Victorian

CERAMICS



Victorian 61cm 2 tap hole basin and pedestal €229 with Claremont 5" pillar taps €151, plug and chain waste €17, rectangular mirror €233 and soap dish €41.

See pages 39 for technical details on the Victorian basin.

Victorian 56cm 1TH, Semi-pedestal.



Victorian 61cm 1TH, with Towel Rail.



A delicate and refined range, the simplicity of this ceramic basin is stunning. Available in a large (61cm) and medium (56cm) with a range of pedestals, and in one, two or three tap hole options.

Victorian basin & wash stand.



PEDESTAL OPTIONS ↓
Available with the Victorian Basins

Burlington Regal pedestals are 6cm higher than the standard pedestal to ensure more ergonomic use for taller individuals.



CERAMICS

This page: Victorian 56cm basin with regal pedestal €258 Claremont 3 tap hole basin mixer with pop-up waste €315, rectangular mirror €233, round light with Chiffon silver shade €205 each, soap dish €41 and towel ring €43.

Opposite: Victorian 56cm basin with chrome basin stand €526 and Claremont 1 tap hole basin mixer with high central indice, click-clack waste €265 and tumbler and holder €40.

See pages 39 for technical details on the Victorian basin.



Victorian 61cm basin with semi-pedestal & towel rail €322, Claremont 5" pillar taps €151, plug and chain waste €17, tumbler and holder €40.

See pages 39 for technical details on the Victorian basin.



BASIN OPTIONS →

Design a bathroom to suit your specific needs

View our Victorian cloakroom basins on page 39 or visit us at burlingtonbathrooms.com

All Victorian basins are available on standard or regal pedestals, semi-pedestals or chrome washstands to suit your own needs and tastes. Also available as cloakroom basin sizes to continue the design linked appearance throughout your home.

Victorian cloakroom 2 tap hole basin with towel rail €242, Claremont 3" basin taps €140, plug and chain waste €17 and bottle trap €46.



Match your exquisite Victorian basin with luxurious fittings and intricate detail with Burlington accessories and a high-level WC with ornate brackets, giving the extra “wow” factor to your period bathroom.

Victorian 61cm 2 tap hole basin and pedestal €229 with Claremont 5” pillar taps €151, plug and chain waste €17, rectangular mirror €233 and soap dish €41, Berkeley radiator (just seen) €350, Burlington round light with chrome base and chiffon silver shade €205. High-level WC white ceramic cistern €625 with oak throne seat €304. Harewood slipper bath with white arc feet €912 and Claremont deck-mounted angled bath shower mixer with ‘S’ adjuster €603 and Fire Hydrant waste €1169.

See pages 39 for technical details on the Victorian basin.



Victorian Basins

VICTORIAN BASINS

Basins				Pedestals						Chrome Basin Stands				Towel Rails (D)	
Width	Depth	Code	Price	Standard (B)		Regal		Semi		Standard (C)		Regal		Code	Price
				Code	Price	Code	Price	Code	Price	Code	Price	Code	Price		
56cm	47cm	B2 z*	€141	P1	€77	P9	€118	P8	€94	T22ACHR	€385	T22ACHR	€445	T1 CHR	€77
61cm (A)	51cm	B3 z*	€153	P1	€77	P9	€118	P8	€94	T23ACHR	€422	T23ACHR	€482	T3 CHR	€78

* Victorian Basins are available with 1, 2 or 3 tap holes. To order the correct basin configuration Simply remove the ‘z’ and replace it with 1TH, 2TH or 3TH.

Overall heights to the top of the front basin surface:

Victorian Basin with Standard Pedestal: 84cm

Victorian Basin with Regal Pedestal: 90cm

Victorian Basin with Basin stand: 84cm

Victorian Basin with Regal basin stand: 90cm



(A)



(A)

(B)

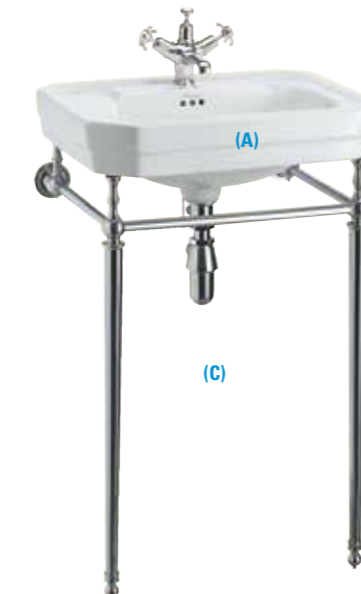

(A)

(C)



(A)

(D)



...on all sanitaryware
See website for details

Contemporary

CERAMICS



Rectangular mirror €233, Contemporary basin and semi-pedestal €258 with Claremont 1 tap hole basin mixer with high central indice and pop-up waste €239.

See page 43 for technical details on the Contemporary basins.

CERAMICS

As the name suggests, the Contemporary collection is styled on the elegance of past times but with a modern day twist. Simplistic, structured lines form the basis for this striking ceramic collection. Available as full pedestal, semi-pedestal or with a chrome washstand.

Contemporary 58cm 1TH, with Towel Rail.



Contemporary 58cm Washstand 1TH.



For a more intergrated look, sink either our semi-recessed or counter-top basins into your bathroom work surfaces.

SEMI-RECESSED BASIN 58CM

One tap hole B121TH

€216

Two tap hole B122TH

€216

COUNTERTOP BASIN 54CM

One tap hole B131TH

€181

Two tap hole B132TH

€181





This page & opposite: Contemporary basin with semi-pedestal €258, with Claremont 1 tap hole basin mixer with high central indice click-clack waste €265. Rectangular mirror €233.

See page 43 for technical details on the Contemporary basin.

Contemporary Basins

CONTEMPORARY BASINS

Basins				Pedestals						Chrome Basin Stands				Towel Rails (D)	
Width	Depth	Code	Price	Standard (B)		Regal		Semi		Standard (C)		Regal		Code	Price
				Code	Price	Code	Price	Code	Price	Code	Price	Code	Price		
58cm (A)	47cm	B2 z*	€165	P1	€77	P9	€118	P8	€94	T22A CHR	€385	T22A CHR+T62	€445	T2 CHR	€77

* Contemporary Basins are available with 1, 2 or 3 tap holes. To order the correct basin configuration Simply remove the 'z' and replace it with 1TH, 2TH or 3TH.

Overall heights to the top of the front basin surface:
 Contemporary Basin with Standard Pedestal: 84cm
 Contemporary Basin with Regal Pedestal: 90cm
 Contemporary Basin with Basin stand: 84cm
 Contemporary Basin with Regal basin stand: 90cm



(A)



(A)

(B)

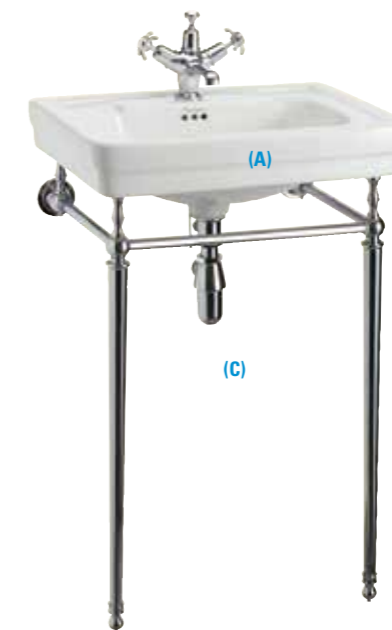

(A)

(C)



(A)

(D)



...on all sanitaryware
See website for details

Stone

Carrara marble top and basin with chrome washstand €1211 with Claremont 3 tap hole basin mixer with pop-up waste €315.

See page 47 for technical details on marble and granite washstands.

CERAMICS



Roll top natural stone basin with stainless steel stand



Burlington stone covers both velvety soft natural stone basins and the divine marble and granite ranges. Pair exquisite pebble grey marble basin tops to either chrome or aluminium washstands. Marble and granite are natural materials, difference in colour, shading and veining are natural characteristics and this is part of their charm.

CERAMICS

Carrera marble & Chrome Washstand.



Carrera marble & Polished Aluminium Washstand.





MARBLE Provides an eye-catching and gorgeous focal point in your vintage setting. The beautiful pebble grey marble can be added to various washstands or even wooden vanity units.

Carrara marble top and basin with chrome washstand €1211 with Claremont 3 tap hole basin mixer with pop-up waste €315, and basin bottle trap €46.

GRANITE & MARBLE ↑
Design a bathroom to suit your specific needs

View all options online at burlingtonbathrooms.com, or look at page 47

All granite and marble basin worktops are provided with matching splashbacks and sides in the same box. Enabling you to tailor make your beautiful basin to your individual tastes.

Georgian Marble Washstands

GEORGIAN MARBLE WASH STANDS

Marble Basins				Chrome Basin Stands				Aluminium Wash Stands (C)		Aluminium Wash Stands with shelf (D)	
Width	Depth	Code	Price	Standard (B)		Regal		Code	Price	Code	Price
58cm (A)	58cm	G1 z*	€673	T49ACHR	€422	T49ACHR+T62	€482	T38 h**	€503	G11 h**+G11	€118

* Marble Basins are available with 1, 2 or 3 tap holes. To order the correct basin configuration Simply remove the 'z' and replace it with 1TH, 2TH or 3TH.

** To order the correct wash stand colour simply remove the 'h' from the product code and replace it with 'ALU' for aluminium, 'BLA' for Black, or 'WHI' for white.

Marble basins can be installed with rear & side upstands, rear upstand only or no upstand

Overall heights to the top of the front basin surface:

Basin with Basin stand: 81cm

Basin with Regal basin stand: 87cm

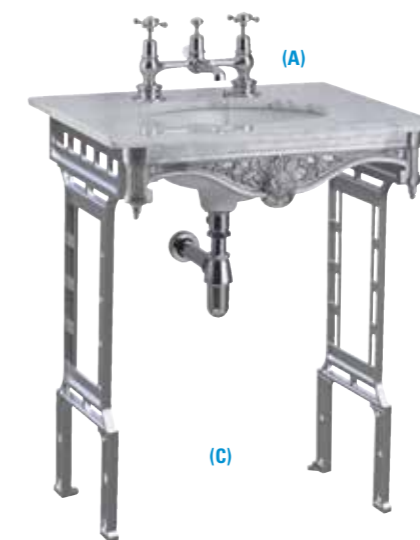

Traditional Natural Stone Basins

NATURAL STONE BASINS & WASH STANDS

Natural Stone Roll Top Basins Basins					Stainless Steel Basin Stands		Complete
Model	Width	Depth	Code	Price	Code	Price	Price
Small	55cm (A)	47cm	B7E	€280	B7ES (D)	€340	€620
Medium	65cm (B)	47cm	B8E	€327	B8ES (E)	€352	€679
Large	75cm (C)	47cm	B9E	€327	B9ES (E)	€385	€712

* Natural Stone basins can no tap hole, 1 tap hole, 2 tap hole or 3 tap hole (drilled on site)
Overall heights, when on a Basin stand, to the top of the front basin surface: 88cm

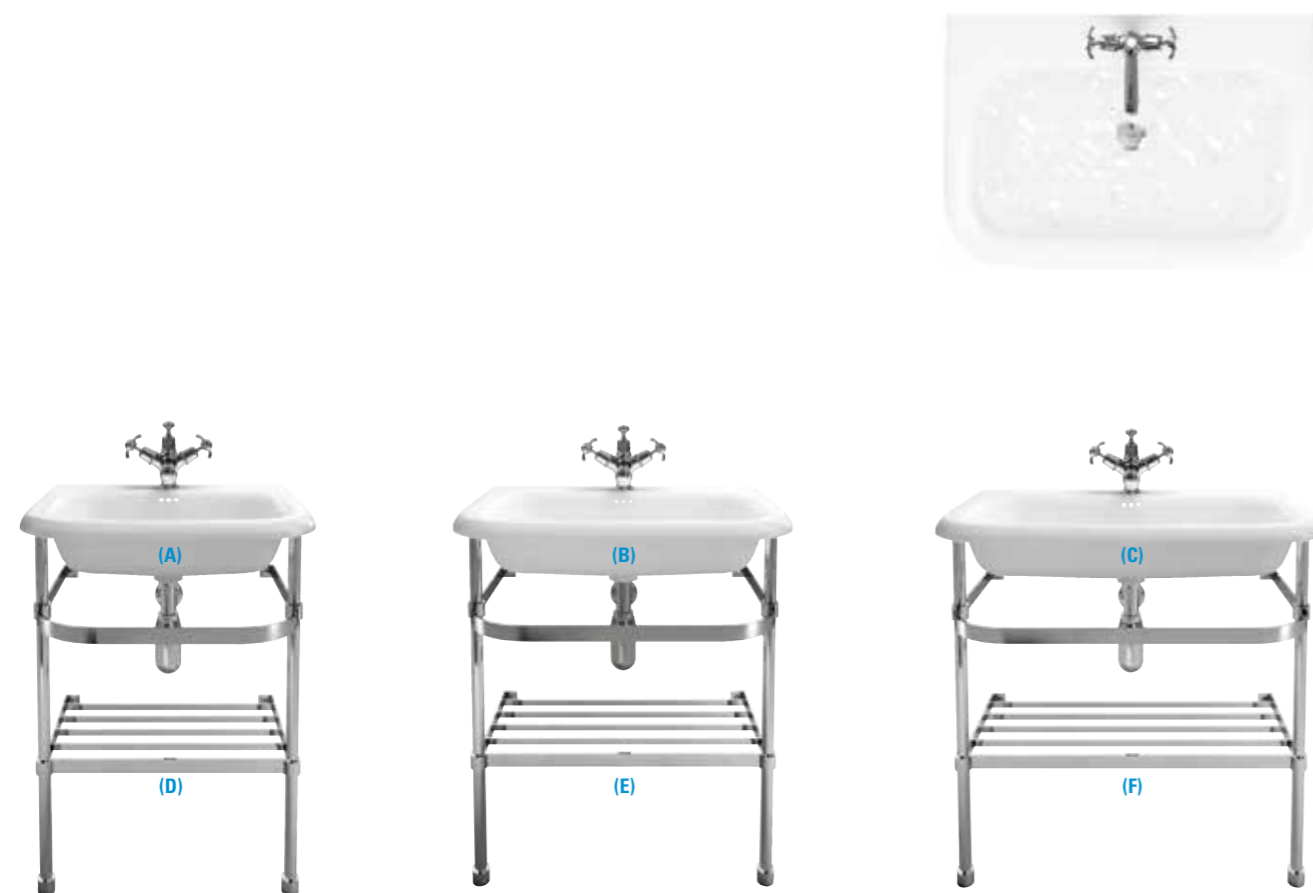

NATURAL STONE A velvety soft natural stone basin available in three sizes. Set these gorgeous basins into countertops or pair with our beautiful stainless steel washstands.

Medium natural stone basin with stainless steel basin stand €678
Claremont 1 tap hole basin mixer with click-clack waste €265, and basin bottle trap €46.

See opposite page 48 for technical details on natural stone basins.



WCs

Burlington WCs come in a range of options, from the more contemporary wall-hung or back-to-wall options, to traditional close-coupled or the impressive low, medium or high-level WCs. All options feature water saving technology, only flushing 6L for a full flush or 3L for a half. These factory settings can be adjusted to 4 ½ L for a full flush or 2 ½L for a half flush. Pair your WC with a real wood seat to accentuate the classic styling. Unlike many other traditional brands, Burlington offer soft-close options on white, oak and mahogany seats. Or for a premium look, select the throne seat with intricate and ornate brackets, which provide a focal point in your stunning vintage bathroom.



25 YEAR GUARANTEE
ON ALL OUR
SANITARYWARE

See website for details

WC OPTIONS

Select a range of alternative cistern and seat options and colours to tailor your WC to your own tastes

For all options visit www.burlingtonbathrooms.com

Close-coupled, low-level and medium-level WCs are available with either a ceramic lever flush, or a more contemporary front flush button. All WCs with a cistern are also available in standard 51cm or slimline 44cm cisterns to add greater flexibility to the placement of your WC. Cisterns come in a range of colours and styles too, from deep mahogany for low-level, to simple white ceramic or for high-level, aluminium in white, black or polished effect.



Wall-hung Back-to-wall Close-coupled Low-level Medium-level High-level

nanoGLAZE
ceramic that stays cleaner

A cleaner toilet, by design and with NANO Glaze

We believe that the toilet bowl should still remain as clean as possible even with reduced flushing water and therefore engineer our toilet bowls to maintain the correct water area as previous British Standards and by coating the toilet bowl with NANO Glaze to make them exceptionally easy to keep clean.



Close Coupled

The most traditional of the WC's, with a narrow width range for those smaller cloakrooms.

CERAMICS



The Edwardian cloakroom range is the perfect addition to small bathrooms where other Edwardian pieces are used throughout the home, giving a cohesive and seamless look and feel. The basin is available as a wall-mounted option, with the addition of a towel rail, or with a chrome washstand.

See page 54 for more Close Coupled WC options



CERAMICS



Edwardian cloakroom basin €170, Claremont 3" pillar taps €140, traditional basin bottle trap €46 and Towel ring €43.

Close-coupled WC with slimline push button cistern €356, soft-close mahogany seat €105 (with chrome handles €116).

Close Coupled WCs, Seats & Bidets

CLOSE COUPLED WC'S

Model	Ceramic	Type*	As Shown	Complete Price**	Width	Depth	Overall Height	Pan Height	Pan Code	Pan Price	Cistern Code	Cistern Price
with ceramic cistern lever	White	P		€328	52cm	73cm	78cm	42cm	P5	€146	C1	€182
with push button	White	P	(B)	€357	52cm	73cm	78cm	42cm	P5	€146	C2	€211
with ceramic cistern lever	English garden	P	(C)	€474	52cm	73cm	78cm	42cm	P5D	€210	C1D	€264
with ceramic cistern lever	White	S		€376	52cm	73cm	78cm	42cm	P18	€194	C24/ C30***	€182
with push button	White	S		€405	51cm	73cm	78cm	42cm	P18	€194	C25	€211

*** C24 rough-in is 21cm. C30 rough-in is 24cm.

REGAL CLOSE COUPLED WC'S

Model	Ceramic	Type*	As Shown	Complete Price**	Width	Depth	Overall Height	Pan Height	Pan Code	Pan Price	Cistern Code	Cistern Price
with ceramic cistern lever	white	P	(A)	€475	52cm	73cm	84cm	48cm	P12	€293	C1	€182
with push button	white	P		€504	52cm	73cm	84cm	48cm	P12	€293	C2	€211

* P means horizontal P trap pan; S means S trap pan

** complete WC price is for a complete WC as described excluding the seat

Note: Rear entry water supply cisterns (with rear entry cistern fittings) are available using Cistern Code: C24 for ceramic cistern lever & C25 for push button

SEATS



Colour	Material	Standard Seat		Soft Close Seat		Soft Close Seat with Handles	
		Code	Price	Code	Price	Code	Price
White	Carbamide	S13	€70	S18	€105	-	-
Oak	Wood	S11	€70	S16	€105	S16+A51 CHR	€116
Mahogany	Wood	S12	€70	S16	€105	S16+A51 CHR	€116
Matt White***	Wood			S45	€105	S45+A51 CHR	€116
Dark Olive***	Wood			S44	€105	S44+A51 CHR	€116
Sand***	Wood			S43	€105	S43+A51 CHR	€116

*** See page 95

BIDETS

Model	Ceramic	Width	As Shown	Price	Depth	Overall Height	Code
Floor Standing	White	40cm	(E)	€235	57cm	40cm	P4
Floor Standing	English Garden	40cm	(F)	€334	57cm	40cm	P4D

Ceramic traps
For converting P-trap pans to S-trap
C26 **€88**

Straight ceramic trap
C29 **€88**



All Burlington WC fittings are factory set at 3L and 6L flush. They can be adjusted on site to flush at 2 1/2L and 4 1/2L.



All Burlington Close-coupled WCs are supplied with dual flush WRAS fittings.



...on all sanitaryware
See website for details

REGAL WCs

Regal WC pans are 6cm higher than the standard option. The taller WC pan ensures the knee angle remains at approximately 90 degrees whilst in use. This provides a more comfortable use for taller people and the elderly but also transforms your bathroom into both a beautiful and functional space.



Regal WCs are available with all Burlington WCs except English Garden and Concealed Bottom Outlet

LEVER OR PUSH BUTTON CISTERN

Available with all Burlington Close-coupled, Low & Mid level WCs

Choose between the classic ceramic flush lever or the more contemporary flush front button.



Lever
51cm Cistern (C1)
44cm Cistern (C3)



Push Button
51cm Cistern (C2)
44cm Cistern (C4)



Edwardian round 56cm basin with pedestal €240, Claremont 5" basin pillar taps €151 and plug and chain waste €17. Low-level WC slimline cistern with front flush button €456 with soft-close oak seat €105 (with chrome handles €116) and ceramic trap €88. WC toilet roll holder €70. London round soaking tub €1638 with floor-standing Claremont bath shower mixer €977. Edwardian single elliptical light €105.

See page 32 for technical details on the round basin.



Rectangular mirror £199, Edwardian single elliptical lights £89 each, Classic basin invisible overflow with standard pedestal £449 and invisible overflow waste £139 and bottle trap £39, Claremont 5" basin pillar taps £129, medium-level WC with ceramic cistern lever £478 with soft-close oak seat £89 (or with chrome handles £99) and ceramic trap £75.

SEATS

Colour	Material	Standard Seat		Soft Close Seat		Soft Close Seat with Handles		Low Level Throne Seat*	
		Code	Price	Code	Price	Code	Price	Code	Price
White	Carbamide	S13	£70	S18	£105	-	-	-	-
Oak	Wood	S11	£70	S16	£105	S16+A51 CHR	£116	S19	£280
Mahogany	Wood	S12	£70	S16	£105	S17+A51 CHR	£116	S20	£280
Matt White***	Wood	-	-	S45	£105	S45+A51 CHR	£116	-	-
Dark Olive***	Wood	-	-	S44	£105	S44+A51 CHR	£116	-	-
Sand***	Wood	-	-	S43	£105	S43+A51 CHR	£116	-	-

*** See page 95

* See page 63 F & G for what a Low Level Throne Seat looks like

BIDETS

Model	Ceramic	Width	As Shown	Price	Depth	Overall Height	Code
Floor Standing	white	40cm	(E)	£234	57cm	40cm	P4
Floor Standing	English Garden	40cm	(F)	£334	57cm	40cm	P4D



Ceramic traps
For converting P-trap pans to S-trap
C26 £88
Straight ceramic trap
C29 £88

LOW & MEDIUM LEVEL WCS



All Burlington WC fittings are factory set at 3L and 6L flush. They can be adjusted on site to flush at 2 1/2L and 4 1/2L.



All Burlington Close-coupled WCs are supplied with dual flush WRAS fittings.

Low & Medium Level WCs, Seats & Bidets

LOW & MEDIUM LEVEL WC'S

Type	Model	Ceramic	Type*	As Shown	Complete Price**	Width	Depth	Overall Height	Pan	Pan Code	Pan Price	Cistern Code	Cistern Price	Flush Pipe Kit Code	Flush Pipe Kit Price
Low Level	ceramic cistern lever	white	P	(A)	£426	52cm	74cm	96-114cm	42cm	P2	£169	C1	£182	T31CHR	£77
Low Level	push button	white	P		£456	52cm	74cm	96-114cm	42cm	P2	£169	C2	£211	T31CHR	£77
Low Level	ceramic cistern lever	English Garden	P	(B)	£584	52cm	74cm	96-114cm	42cm	P2D	£245	C1D	£264	T31CHR	£77
Low Level	ceramic cistern lever	white	S		£451	52cm	74cm	96-114cm	42cm	P19	£194	C24/C30***	£182	T31CHR	£77
Low Level	push button	white	S		£480	45cm	74cm	96-114cm	42cm	P19	£194	C25	£211	T31CHR	£77
Medium Level	ceramic cistern lever	white	P	(C)	£560	52cm	71cm	134-143cm	42cm	P5	£146	C1	£182	T33CHR	£233
Medium Level	push button	white	P		£390	52cm	71cm	134-143cm	42cm	P5	£146	C2	£211	T33CHR	£233
Medium Level	ceramic cistern lever	English Garden	P	(D)	£706	52cm	71cm	134-143cm	42cm	P5D	£210	C1D	£264	T33CHR	£233

*** C24 rough-in is 26cm to 33cm. C30 rough-in is 29cm to 36cm.

REGAL HEIGHT WC'S

Type	Model	Ceramic	For use in*	As Shown	Complete Price**	Width	Depth	Overall Height	Pan	Pan Code	Pan Price	Cistern Code	Cistern Price	Flush Pipe Kit Code	Flush Pipe Kit Price
Low Level	ceramic cistern lever	white	UK		£562	52cm	74cm	96-114cm	48cm	P16	£305	C1	£182	T31CHR	£77
Low Level	push button	white	UK		£591	52cm	74cm	96-114cm	48cm	P16	£305	C2	£305	T31CHR	£77

* P means horizontal P trap pan; S means S trap pan

** complete WC price is for a complete WC as described excluding the seat

Note: Rear entry water supply cisterns (with rear entry cistern fittings) are available using Cistern Code: C24 for ceramic cistern lever & C25 for push button



Prices exclude VAT

HIGH-LEVEL WCS ↓
Design a bathroom to suit your specific needs

View the full range of WCs on pages 113

The angled high-level WC is a great option for those wanting to achieve the wow factor achieved with this type of WC, but needing to work around windows or within awkwardly shaped bathrooms. All high-level WCs are also supplied with a rigid pull rod to enable water saving; pull down for a full flush of 6 litres, or push up for a half flush of 3 litres. This can also be adjusted to 4.5 litres and 2.5 litres if required. Also available is a single flush chain and ceramic pull.

Toilet roll holder €70, High-level WC with white ceramic cistern and angled extension pipes €801 with mahogany soft-close seat €105 (with chrome handles €116).

See page 62 for technical details on high-level WCs.

Match your exquisite Victorian basin with luxurious fittings and intricate detail with Burlington accessories and a high-level WC with ornate brackets, giving the extra wow factor to your period bathroom.

Victorian 61cm 2 tap hole basin and pedestal €229 with Claremont 5" pillar taps €151, plug and chain waste €17, rectangular mirror €233 and soap dish €41, Berkeley radiator (just seen) €350, Burlington round light with chrome base and chiffon silver shade €205. High-level WC white ceramic cistern €625 with oak throne seat €304. Harewood slipper bath with white arc feet €912 and Claremont deck-mounted angled bath shower mixer with 'S' adjuster €603 and Fire Hydrant waste €1168.

See page 39 for technical details on the Victorian basin.

High Level WCs, Seats & Bidets

HIGH LEVEL WC'S

Type	Model	Ceramic	Type*	As Shown	Complete Price**	Width	Depth	Overall Height	Pan	Pan Code	Pan Price	Cistern Code	Cistern Price	Flush Pipe Kit Code	Flush Pipe Kit Price
High Level	Ceramic cistern	white	P	(A)	£624	52cm	67cm	230-238cm	42cm	P2	£169	C5	£211	T30CHR	£246
High Level	Polished aluminium cistern	white	P	(B)	£999	43cm	67cm	232-240cm	42cm	P2	£169	T58ALU	£584	T30CHR	£246
High Level	Black aluminium cistern	white	P	(C)	£999	43cm	67cm	232-240cm	42cm	P2	£169	T60BLA	£584	T30CHR	£246
High Level	White aluminium cistern	white	P	(D)	£999	43cm	67cm	232-240cm	42cm	P2	£169	T59WHI	£584	T30CHR	£246
High Level	Ceramic	English Garden	P	(E)	£798	52cm	67cm	230-238cm	42cm	P2D	£245	C5D	£297	T30CHR	£246
High Level	Ceramic Single Flush cistern	white	P		£649	52cm	67cm	230-238cm	42cm	P2	£169	C28	£234	T30CHR	£246
High Level	Ceramic cistern	white	S		£650	51cm	67cm	230-238cm	42cm	P19	£194	C5	£211	T30CHR	£246
High Level	Polished aluminium cistern	white	S		£1023	51cm	67cm	230-238cm	42cm	P19	£194	T58ALU	£584	T30CHR	£246

* P means horizontal P trap pan; S means S trap pan
 All of the High Level combinations listed on this page are available as Angled High Level WC's (as shown on page 60). To order this simply replace T30CHR Flush Pipe Kit with T34CHR Flush Pipe Kit and add £150 to the overall cost

** Complete WC price is for a complete WC as described excluding the seat. All cisterns are dual flush except C28

Note: Rear entry water supply cisterns (with rear entry cistern fittings) are available using Cistern Code: C24 for ceramic cistern lever & C25 for push button



All Burlington WC fittings are factory set at 3L and 6L flush. They can be adjusted on site to flush at 2 1/2L and 4 1/2L.



All Burlington Close-coupled WCs are supplied with dual flush WRAS fittings.



...on all sanitaryware
 See website for details

REGAL HEIGHT WC'S

Type	Model	Ceramic	For use in*	As Shown	Complete Price**	Width	Depth	Overall Height	Pan	Pan Code	Pan Price	Cistern Code	Cistern Price	Flush Pipe Kit Code	Flush Pipe Kit Price
High Level	Ceramic cistern	white	P		£761	52cm	74cm	236-244cm	48cm	P16	£305	C5	£211	T30CHR	£246
High Level	Polished aluminium cistern	white	P		£1134	52cm	74cm	236-244cm	48cm	P16	£305	T58ALU	£584	T30CHR	£246
High Level	Black aluminium cistern	white	P		£1134	52cm	74cm	236-244cm	48cm	P16	£305	T60BLA	£584	T30CHR	£246
High Level	White aluminium cistern	white	P		£1134	52cm	74cm	236-244cm	48cm	P16	£305	T59WHI	£584	T30CHR	£246
High Level	Ceramic Single Flush cistern	white	P		£784	52cm	74cm	236-244cm	48cm	P16	£305	C28	£234	T30CHR	£246
High Level	Ceramic cistern with angled flush pipe kit	white	P		£936	52cm	74cm	236-244cm	48cm	P16	£305	C5	£211	T34CHR	£422

* Angled flush pipe kit can be used with all high level cisterns

SEATS



Colour	Material	Standard Seat		Soft Close Seat		Soft Close Seat with Handles		High Level Throne Seat	
		Code	Price	Code	Price	Code	Price	Code	Price
White	Carbamide	S13	£70	S18	£105	S18+A51 CHR	£116	-	-
Oak	Wood	S11	£70	S16	£105	S16+A51 CHR	£116	S14	£304 (F)
Mahogany	Wood	S12	£70	S17	£105	S17+A51 CHR	£116	S15	£304 (G)
Matt White***	Wood	-	-	S45	£105	S45+A51 CHR	£116	-	-
Dark Olive***	Wood	-	-	S44	£105	S44+A51 CHR	£116	-	-
Sand***	Wood	-	-	S43	£105	S43+A51 CHR	£116	-	-

*** See page 95

BIDETS

Model	Ceramic	Width	As Shown	Price	Depth	Overall Height	Code
Floor Standing	white	40cm	(H)	£234	57cm	40cm	P4
Floor Standing	English garden	40cm	(I)	£334	57cm	40cm	P4D



Ceramic traps
 For converting P-trap pans to S-trap
 C26 £88
 Straight ceramic trap
 C29 £88





Wall-hung WC €275 with concealed lever cistern €211 and soft-close white seat €105. Wall-hung bidet €240 with Claremont bidet mixer with pop-up waste €245. Tissue holder €70.

Back to Wall and Wall Hung WCs & Bidets

BACK TO WALL & WALL HUNG WC'S

Type	Model	Ceramic	Type*	As Shown	Price	Width	Depth	Height	Code
Back to wall	Standard height WC	white	P	(A)	€258	37cm	48cm	42cm	P14
Back to wall	Regal height WC	white	P		€315	37cm	48cm	48cm	P15
Wall Hung	WC	white	P	(B)	€275	37cm	50cm	36cm	P10



For seats see page 54

BIDETS

Model	Ceramic	Ceramic	Type*	As Shown	Price	Width	Depth	Height	Code
Floor Standing	Standard height bidet	white	P	(C)	€234	40cm	57cm	40cm	P4
Wall Hung	-	white	P	(D)	€240	36cm	50cm	35cm	P11



* P means horizontal P trap pan; S means S trap pan

** complete WC price is for a complete WC as described excluding the seat



Semi recessed 58cm basin €216, back to wall WC €387 and Burlington soft close seat in Sand €105.

For furniture see page 90 & 91



...on all sanitaryware
See website for details



CERAMICS

CERAMICS

Cloakroom basins

Throughout the Burlington range of stunning ceramic styles, a selection of cloakroom options have been crafted so you can match your chosen style throughout the home. You'll find Edwardian, Victorian and more Classic styled cloakroom basins to achieve a consistent and beautiful look throughout every washroom.

See pages 71 for technical details on all our cloakroom basins.



Victorian cloakroom basin with chrome washstand €549 with Claremont 3" basin taps €140 basin plug and chain €17 and traditional basin bottle trap €46.



VICTORIAN CLOAKROOM

Victorian cloakroom basin €164 with Claremont 3" basin taps €140 basin plug and chain €17 and traditional basin bottle trap €46.

EDWARDIAN CLOAKROOM

Edwardian cloakroom basin with towel rail €247 with Claremont 3" basin taps €140, basin plug and chain €17 and traditional basin bottle trap €46.



CORNER CLOAKROOM

Corner cloakroom basin €170 with Chelsea straight basin tap without waste €210, basin plug and chain €17 and traditional basin bottle trap €46.

CURVED CLOAKROOM

Curved cloakroom basin €170 with Claremont 3" basin taps €140, basin plug and chain €17 and traditional basin bottle trap €46.

Every cloakroom basin is available as wall-mounted, with or without a towel rail or alternatively a chrome washstand, except the Curved basin. View the full range of options on page 71.

Cloakroom WCs & Seats



On all sanitaryware
See website for details

STANDARD HEIGHT WC'S

Type	Model	Ceramic	Pan*	As Shown	Complete Price**	Width	Depth	Overall Height	Pan	Pan Code	Pan Price	Cistern Code	Cistern Price	Flush Pipe Kit Code	Flush Pipe Kit Price
Close Coupled	ceramic cistern lever	white	P	(A)	€356	44cm	71cm	78cm	42cm	P5	€146	C3	€211	-	-
Close Coupled	push button	white	P		€356	44cm	71cm	78cm	42cm	P5	€146	C4	€211	-	-
Close Coupled	ceramic cistern lever	white	S		€404	44cm	71cm	78cm	42cm	P18	€197	C3	€211	-	-
Close Coupled	push button	white	S		€404	44cm	71cm	78cm	42cm	P18	€197	C4	€211	-	-
Low Level	ceramic cistern lever	white	P		€456	44cm	71cm	114cm	42cm	P2	€169	C3	€211	T31CHR	€77
Low Level	push button	white	P		€456	44cm	71cm	114cm	42cm	P2	€169	C4	€211	T31CHR	€77
Low Level	ceramic cistern lever	white	S		€479	44cm	74cm max	114cm max	42cm	P19	€197	C3	€211	T31CHR	€77
Low Level	push button	white	S		€479	44cm	74cm max	114cm max	42cm	P19	€197	C4	€211	T31CHR	€77

REGAL HEIGHT WC'S

Type	Model	Ceramic	Pan*	As Shown	Complete Price**	Width	Depth	Overall Height	Pan	Pan Code	Pan Price	Cistern Code	Cistern Price	Flush Pipe Kit Code	Flush Pipe Kit Price
Close Coupled	ceramic cistern lever	white	P		€580	44cm	73cm	78cm	48cm	P12	€293	C2	€211	T31CHR	€77
Close Coupled	push button	white	P		€580	44cm	73cm	78cm	48cm	P12	€293	C2	€211	T31CHR	€77
Low Level	ceramic cistern lever	white	P		€591	44cm	74cm	114cm	48cm	P16	€305	C3	€211	T31CHR	€77
Low Level	push button	white	P		€591	44cm	74cm	114cm	48cm	P16	€305	C4	€211	T31CHR	€77

* P means horizontal P trap pan; S means S trap pan

** complete WC price is for a complete WC as described excluding the seat

Note: Rear entry water supply cisterns (with rear entry cistern fittings) are available using Cistern Code: C24 for ceramic cistern lever & C25 for push button



SEATS

Colour	Material	Standard Seat		Soft Close Seat		Soft Close Seat with Handles		Low Level Throne Seat	
		Code	Price	Code	Price	Code	Price	Code	Price
White	Carbamide	S13	€70	S18	€105	S18+A51 CHR	€116	-	-
Oak	Wood	S11	€70	S16	€105	S16+A51 CHR	€116	S19	€280
Mahogany	Wood	S12	€70	S16	€105	S16+A51 CHR	€116	S20	€280
Matt White***	Wood	-	-	S45	€105	S45+A51 CHR	€116	-	-
Dark Olive***	Wood	-	-	S44	€105	S44+A51 CHR	€116	-	-
Sand***	Wood	-	-	S43	€105	S43+A51 CHR	€116	-	-

*** See page 95

* See page 63 F & G for what a Low Level Throne Seat looks like

Cloakroom Basins

CLOAKROOM BASINS

Basin	Basins				Chrome Basin Stands				Towel Rails (F)	
	Width	Depth	Code	Price	Standard (E)		Regal		Code	Price
Edwardian Rectangular (A)	51cm	32cm	B8*	€170	T21A CHR	€385	T21A CHR+T62	€456	T6 CHR	€78
Victorian Rectangular (B)	51cm	32cm	B9	€164	T21A CHR	€385	T21CHR+T62	€456	T6 CHR	€78
Curved (C)	51cm	26cm	P13*	€170						
Corner (D)	60cm	45cm	B10	€170					T8 CHR	€78

* Edwardian & Curved Cloakroom basins are available with one tap hole on the right. To order this simply add 'R' to the product code.



(A)



(B)



(C)



(D)



(E)



(F)



(F)



(F)



(F)



(E)



(E)



Surface mounted soap dispenser
Chrome (can be mounted through a ceramic basin tap hole or a work surface)
L: 11cm, W: 7cm, D: 7cm
A48 CHR **€105**



Tap hole stopper
Chrome
A49 CHR **€23**

Furniture

Introducing the latest in furniture innovation from Burlington. A range of beautifully traditional furniture solutions to add classic style and sophisticated British elegance to your bathroom.

Choose from free-standing in either a square or curved design, wall-hung or fully-fitted options to tailor make the most functional use of space to suit your individual needs. A new range of baths each with panels or surrounds in corresponding colours, transform your entire bathroom into a space of peace and tranquillity with a subtle, traditionally British feel.

Each piece is packed full of innovative detailing such as soft close doors and drawers, internal lighting and wide opening spaces for maximum storage capacity.



65 Freestanding

The 65 free-standing furniture with your choice of basin is the perfect solution for those needing to save space but still require storage solutions for their bathroom. With a width of just 65cm, this stylish piece combines beautiful ceramic or integrated basins atop units with either drawers or doors so you can tailor your bathroom to your preferred style.

Sand Freestanding 65 Vanity Unit with doors €702, 65cm Classic basin for integrated waste & overflow with two tapholes €409, Birkenhead Basin taps 5" €151, Basin Plug and Chain €17, 60cm Mirror without LED in Sand €233

See pages 76-77 for technical details.

FURNITURE



FURNITURE

Ergonomic comfort – Each of the Burlington free-standing furniture pieces are set to a height of 85cm to avoid over stretching or bending to wash your hands, making them exceptionally comfortable to use.

Above left; Sand Freestanding 65 Vanity Unit with doors €702, 65cm Classic basin for integrated waste & overflow with two tapholes €409, Claremont two taphole Arch mixer €339, Classic basin invisible overflow & waste €163, 60cm Mirror without LED in Sand €233.

Above; Dark Olive Freestanding 65 Vanity Unit with doors €702, 67cm x 55cm Minerva Carrara White with integrated basin with one taphole €701, Claremont basin mixer with high central indice with click-clack waste €265, 60cm LED Mirror in Dark Olive €467.

Left; Matt White Freestanding 65 Vanity Unit with 2 drawers €702, 67cm x 55cm Minerva Black Granite with integrated basin with three tapholes €701, Claremont three taphole basin mixer with pop up waste €315, 50cm x 70cm Rectangular Mirror €233.

3 COLOURS

Sand, Matt White & Dark Olive



65 Vanity Units with Doors

65 VANITY UNITS WITH DOORS

Complete Vanity Unit Sizes						Vanity Unit Codes, Colours & Prices					
Complete Unit	Type	Width	Depth	Height	+ Splash	Matt White		Sand		Olive	
						Code	Price	Code	Price	Code	Price
Free-standing 65 vanity unit with doors & Classic 65 basin for standard waste & overflow	2 Doors	67	58	93	-	FF8W +B15	€994	FF8S +B15	€1111	FF8O +B15 (A)	€1111
Free-standing 65 vanity unit with doors & Classic 65 basin for integrated waste & overflow	2 Doors	67	58	93	-	FF8W +B14	€994	FF8S +B14	€1111	FF8O +B14 (B)	€1111
Free-standing 65 vanity unit with doors & Minerva® Carrara White with vanity bowl	2 Doors	67	55	93	93	FF8W +BC66	€1286	FF8S +BC66 (C)	€1403	FF8O +BC66	€1403
Free-standing 65 vanity unit with doors & Minerva® White with vanity bowl	2 Doors	67	55	93	93	FF8W +BW66	€1169	FF8S +BW66	€1286	FF8O +BW66 (D)	€1286
Free-standing 65 vanity unit with doors & Minerva® Black Granite with vanity bowl	2 Doors	67	55	93	93	FF8W +BB66 (E)	€1286	FF8S +BB66	€1403	FF8O +BB66	€1403

65 Vanity Units with Drawers

65 VANITY UNITS WITH DRAWERS

Complete Vanity Unit Sizes						Vanity Unit Codes, Colours & Prices					
Complete Unit	Type	Width	Depth	Height	+ Splash	Matt White		Sand		Olive	
						Code	Price	Code	Price	Code	Price
Free-standing 65 vanity unit with drawers & Classic 65 basin for standard waste & overflow	2 Drawer	67	58	93	-	FF9W +B15	€1111	FF9S +B15	€1228	FF9O +B15 (A)	€1228
Free-standing 65 vanity unit with drawers & Classic 65 basin for integrated waste & overflow	2 Drawer	67	58	93	-	FF9W +B14	€1111	FF9S +B14	€1228	FF9O +B14 (B)	€1228
Free-standing 65 vanity unit with drawers & Minerva® Carrara White with vanity bowl	2 Drawer	67	55	85	93	FF9W +BC66	€1403	FF9S +BC66	€1520	FF9O +BC66 (C)	€1520
Free-standing 65 vanity unit with drawers & Minerva® White with vanity bowl	2 Drawer	67	55	85	93	FF9W +BW66 (D)	€1286	FF9S +BW66	€1403	FF9O +BW66	€1403
Free-standing 65 vanity unit with drawers & Minerva® Black Granite with vanity bowl	2 Drawer	67	55	85	93	FF9W +BB66	€1403	FF9S +BB66 (E)	€1520	FF9O +BB66	€1520



MINERVA CARE KIT

To restore your Minerva work top to its original best use the Care Kit to buff out all tiny scratches and scuffs. The kit contains all the sanding / buffing materials and liquids required.

BCARE €59



HDP

The plinths of the free-standing furniture are crafted from HDP Polymer - a waterproof base providing extra protection and giving peace of mind that wet floors will not lead to damage.



INFORMATION

Dimensions & Technical Drawings: Dimensional drawings and technical details are shown at burlingtonbathrooms.com/furniture

3 COLOURS
Sand, Matt White & Dark Olive

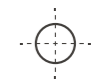

Tap holes: Minerva® worktops are supplied with an integrated bowl with overflow, and no tap holes. Tap holes are drilled by the installer in the required position and configuration. A template is provided with the Minerva® tops indicating tap hole positions and sizes.

Solid craftsmanship – All free-standing furniture pieces are supplied fully assembled for ease of installation. A combination of MDF and water-proof, PVC coated chipboard plinths ensure a rigid construction and means they'll continue to look their best for years to come.

Sand 130 Freestanding Vanity Unit with Drawers €1989, 130cm x 55cm
Minerva Black Granite with two integrated basins with one taphole €1169, Chelsea Straight Basin Mixers with pop up (two required) €233 each, 90cm Sand Mirror without LED €327.



HDP

The plinths of the free-standing furniture are crafted from HDP Polymer - a waterproof base providing extra protection and giving peace of mind that wet floors will not lead to damage.



130 Freestanding

Why not select the double basin option for a traditionally British feel. Choose from three exclusive Minerva® worktop colours available in either pristine White, opulent Black Granite, or luxurious Carrara White, each with a generous sized double basin bowl of 38x31cm. Each of the Burlington furniture pieces are equipped with soft-close door hinges and drawer runners for that extra feeling of indulgence in your bathroom. Select either the four drawer or double doors option to match your storage requirements.

Matt White 1300 Freestanding Vanity Unit with Doors €1404, 130cm x 55cm
Minerva Carrara White with two integrated basins with one taphole €1169, Kensington Basin Mixer with click clack waste (two required) €265 each, Matt White 90cm LED Mirror €584.

See pages 80-81 for technical details

3 COLOURS
Sand, Matt White & Dark Olive



130 Vanity Units with Doors

130 VANITY UNITS WITH DOORS

Complete Vanity Unit Sizes						Vanity Unit Codes, Colours & Prices					
Complete Unit	Type	Width	Depth	Height	+ Splash	Matt White		Sand		Olive	
						Code	Price	Code	Price	Code	Price
Free-standing 130 vanity unit with doors & Minerva® Carrara White with double vanity bowl	4 Door	130	55	85	93	FC9W +BC12 (A)	£2807	FC9S +BC12	£2573	FC9O +BC12	£2573
Free-standing 130 vanity unit with doors & Minerva® White with double vanity bowl	4 Door	130	55	85	93	FC9W +BW12	£2573	FC9S +BW12 (B)	£2339	FC9O +BW12	£2339
Free-standing 130 vanity unit with doors & Minerva® Black Granite with double vanity bowl	4 Door	130	55	85	93	FC9W +BB12	£2807	FC9S +BB12	£2573	FC9O +BB12 (C)	£2573

INFORMATION



Dimensions & Technical Drawings: Dimensional drawings and technical details are shown at burlingtonbathrooms.com/furniture



Tap holes: Minerva® worktops are supplied with an integrated bowl with overflow, and no tap holes. Tap holes are drilled by the installer in the required position and configuration. A template is provided with the Minerva® tops indicating tap hole positions and sizes.



HDP

The plinths of the free-standing furniture are crafted from HDP Polymer - a waterproof base providing extra protection and giving peace of mind that wet floors will not lead to damage.

3 COLOURS
Sand, Matt White & Dark Olive



130 Vanity Units with Drawers

130 VANITY UNITS WITH DRAWERS

Complete Vanity Unit Sizes						Vanity Unit Codes, Colours & Prices					
Complete Unit	Type	Width	Depth	Height	+ Splash	Matt White		Sand		Olive	
						Code	Price	Code	Price	Code	Price
Free-standing 130 vanity unit with drawers & Minerva® Carrara White with double vanity bowl	4 Drawer	130	55	85	93	FC10W +BC12 (A)	£2924	FC10S +BC12	£3158	FC10O +BC12	£3158
Free-standing 130 vanity unit with drawers & Minerva® White with double vanity bowl	4 Drawer	130	55	85	93	FC10W +BW12	£2690	FC10S +BW12 (B)	£2924	FC10O +BW12	£2924
Free-standing 130 vanity unit with drawers & Minerva® Black Granite with double vanity bowl	4 Drawer	130	55	85	93	FC10W +BB12	£2924	FC10S +BB12	£3158	FC10O +BB12 (C)	£3158



WHY MINERVA®?
Design a bathroom to suit your specific needs

Minerva® worktops offer superior strength with a beautiful finish. You can even install a surface mounted soap dispenser. See page 188.



ROUTINE CLEANING

Minerva® does not require any specialist cleaning regimes, most dirt and light residue will easily wipe off with a damp cloth and soapy water. The work surface should then be rinsed with clean water and wiped dry. Persistent marks can be removed by using a mild abrasive cleaner, but harsh scouring powders should be avoided.



134 / 100 Curved

Our free-standing round design cabinets feature open wide doors for easy access to ample storage space. Perfect for hiding away everyday bathroom necessities and keeping worktops free from clutter. This striking piece is available either as a centrepiece or as left and right handed options for perfect placement against a wall or into a corner.

Above left; Matt White 134 Curved Freestanding Vanity Unit with Doors and Drawers €1755, 134cm x 55cm Minerva Carrara White with integrated basin with three tapholes €1111, Claremont Regent three taphole basin mixer with pop up waste €385, Matt White 120cm Mirror without LED €409.

Above right; Matt White Freestanding 100 Curved Corner Vanity Unit with Right Hand Door €1170, 134cm x 55cm Minerva Carrara White with right handed integrated basin with three tapholes €701, Anglesey three tap hole mixer with pop up waste €315.

Opposite; Dark Olive 134 Curved Freestanding Vanity Unit with Doors and Drawers €2106, 134cm x 55cm Minerva Carrara White with integrated basin with three tapholes €1111, Kensington Regent three taphole basin mixer with pop up waste €385, 50cm x 70cm Arched Mirror €233, Two Burlington Ornate lights with Vase clear glass shades €205 each.

See pages 84-85 for technical details

5 LAYERS OF PAINT ↓

Unique features and benefits:

Each of our furniture pieces are prepared with 5 layers of primer featuring UV stabilisation to minimise colour fading from exposure to sunlight. The painted top coat is then applied for glorious depth of colour.



3 COLOURS

Sand, Matt White & Dark Olive



134 Curved Vanity Units

134 CURVED VANITY UNITS

Complete Vanity Unit Sizes						Vanity Unit Codes, Colours & Prices					
Complete Unit	Type	Width	Depth	Height	+ Splash	Matt White		Sand		Olive	
						Code	Price	Code	Price	Code	Price
Free-standing 134 curved vanity unit with doors & Minerva® White with vanity bowl	4 Door	134	55	85	93	FC1W +BW13	€2632	FC1S +BW13	€2866	FC10 +BW13 (A)	€2866
Free-standing 134 curved vanity unit with doors & Minerva® Black Granite with vanity bowl	4 Door	134	55	85	93	FC1W +BB13 (B)	€2866	FC1S +BB13	€3100	FC10 +BB13	€3100
Free-standing 134 curved vanity unit with doors & Minerva® Carrara White with vanity bowl	4 Door	134	55	85	93	FC1W +BC13	€2866	FC1S +BC13 (C)	€3100	FC10 +BC13	€3100
Free-standing 134 curved vanity unit with doors & drawers & Minerva® White with vanity bowl	2 Drawer 2 Door	134	55	85	93	FC4W +BW13	€2749	FC4S +BW13	€2983	FC40 +BW13 (D)	€2983
Free-standing 134 curved vanity unit with doors & drawers & Minerva® Black Granite with vanity bowl	2 Drawer 2 Door	134	55	85	93	FC4W +BB13 (E)	€2983	FC4S +BB13	€3217	FC40 +BB13	€3217
Free-standing 134 curved vanity unit with doors & drawers & Minerva® Carrara White with vanity bowl	2 Drawer 2 Door	134	55	85	93	FC4W +BC13	€2983	FC4S +BC13 (F)	€3217	FC40 +BC13	€3217



STAINING

Minerva®, unlike marble and granite, is not porous and will resist most household chemicals including alcohol and cosmetics, however, some chemicals and strong dyes can cause damage and discolouration. If spillage occurs, wipe off immediately and rinse the area thoroughly.



100 Curved Vanity Units

100 CURVED VANITY UNITS

Complete Vanity Unit Sizes						Vanity Unit Codes, Colours & Prices					
Complete Unit	Type	Width	Depth	Height	+ Splash	Matt White		Sand		Olive	
						Code	Price	Code	Price	Code	Price
Free-standing 100 curved left handed vanity unit with doors & Minerva® White with left handed vanity bowl	LH 3 Door	98	55	85	93	FC2W +BW98L	€1754	FC2S +BW98L	€1871	FC20 +BW98L (A)	€1871
Free-standing 100 curved left handed vanity unit with doors & Minerva® Black Granite with left handed vanity bowl	LH 3 Door	98	55	85	93	FC2W +BB98L (B)	€1871	FC2S +BB98L	€1988	FC20 +BB98L	€1988
Free-standing 100 curved left handed vanity unit with doors & Minerva® Carrara White with left handed vanity bowl	LH 3 Door	98	55	85	93	FC2W +BC98L	€1871	FC2S +BC98L (C)	€1988	FC20 +BC98L	€1988
Free-standing 100 curved right handed vanity unit with doors & Minerva® White with right handed vanity bowl	RH 3 Door	98	55	85	93	FC3W +BW98R	€1754	FC3S +BW98R	€1871	FC30 +BW98R (D)	€1871
Free-standing 100 curved right handed vanity unit with doors & Minerva® Black Granite with right handed vanity bowl	RH 3 Door	98	55	85	93	FC3W +BB98R (E)	€1871	FC3S +BB98R	€1988	FC30 +BB98R	€1988
Free-standing 100 curved right handed vanity unit with doors & Minerva® Carrara White with right handed vanity bowl	RH 3 Door	98	55	85	93	FC3W +BC98R	€1871	FC3S +BC98R (F)	€1988	FC30 +BC98R	€1988



65 Wall Hung Units

65 WALL HUNG UNITS

Complete Unit	Type	Complete Vanity Unit Sizes				Vanity Unit Codes, Colours & Prices					
		Width	Depth	Height	+ Splash	Matt White		Sand		Olive	
						Code	Price	Code	Price	Code	Price
A: Wall-hung 60 vanity unit with single drawer & Classic basin for standard waste & overflow	1 Drawer	66	58	58	-	FW1W +B15	€2222	FW1S +B15	€2222	FW10 +B15 (A)	€2222
B: Wall-hung 60 vanity unit with single drawer & Classic basin for integrated waste & overflow	1 Drawer	66	58	58	-	FW1W +B14	€2222	FW1S +B14	€2222	FW10 +B14 (B)	€2222
C: Wall-hung 60 vanity unit with single drawer & Minerva® Carrara White with vanity bowl	1 Drawer	67	55	51	59	FW1W +BC66	€1345	FW1S +BC66 (C)	€1345	FW10 +BC66	€1345
D: Wall-hung 60 vanity unit with single drawer & Minerva® White with vanity bowl	1 Drawer	67	55	51	59	FW1W +BW66	€1228	FW1S +BW66	€1228	FW10 +BW66 (D)	€1228
E: Wall-hung 60 vanity unit with single drawer & Minerva® Black Granite with vanity bowl	1 Drawer	67	55	51	59	FW1W +BB66 (E)	€1345	FW1S +BB66	€1345	FW10 +BB66	€1345



MINERVA CARE KIT

To restore your Minerva work top to its original best use the Care Kit to buff out all tiny scratches and scuffs. The kit contains all the sanding / buffing materials and liquids required.

BCARE €59

INFORMATION

Dimensions & Technical Drawings: Dimensional drawings and technical details are shown at burlingtonbathrooms.com/furniture



Tap holes: Minerva® worktops are supplied with an integrated bowl with overflow, and no tap holes. Tap holes are drilled by the installer in the required position and configuration. A template is provided with the Minerva® tops indicating tap hole positions and sizes.

INTEGRATED LIGHTING

Unique features and benefits:

Add an additional drawer light to illuminate your vanity unit when movement is detected.

LED1 €39



65 Wall Hung Units

For those wishing to create the illusion of space, Burlington furniture offers a range of wall-hung basin units to keep floor space clear and make cleaning your bathroom easier. 65cm cabinets are available with integrated ceramic basins, or basins set into Minerva® work surfaces for the ultimate feeling of luxury.



Matt white Wall Hung 65 Vanity Unit with a single drawer €644, 66cm x 55cm Minerva White with integrated basin with one tap hole €584, Claremont basin mixer with high central indice with click-clack waste €265, Matt White 60cm LED Mirror €350.

See opposite page for technical details



INFORMATION

Dimensions & Technical Drawings: Dimensional drawings and technical details are shown at burlingtonbathrooms.com/furniture



Tap holes: Minerva® worktops are supplied with an integrated bowl with overflow, and no tap holes. Tap holes are drilled by the installer in the required position and configuration. A template is provided with the Minerva® tops indicating tap hole positions and sizes.



3 COLOURS
Sand, Matt White & Dark Olive



*To order the correct furniture colour simply remove the 'z' from the product code and replace it with:
S for Sand (ie FF8S)
O for Dark Olive (ie FF8O)
W for Matt White (ie FF8W)

134 & 100 Curved Wall Units

Curved cabinets come in either a centre design or left or right handed options to place in corners for further flexibility. Pair yours with the 10cm splash-back provided to offer greater protection to your paint-work, wallpaper or grouting. Every furniture piece features exquisitely crafted brass handles for a delicate vintage feel of superior quality.

Above top; Sand Wall Hung 134 Curved Vanity unit €1393, 134cm x 55cm Minerva White with one integrated basin with one tap hole €877, Chelsea Curved Basin Mixer with pop up waste €233, Matt White 90cm Mirror without LED €327.

Above bottom; Dark Olive Right Handed Wall Hung 100 Curved Corner Vanity Unit €1052, 98cm x 55cm Minerva Carrara White with right handed integrated basin with three tap holes €701, Anglesey three tap hole basin mixer with pop up waste €315, Dark Olive 90cm Mirror without LED €327.

134 & 100 Curved Wall Units

134 & 100 CURVED WALL UNITS

Complete Unit	Type	Complete Vanity Unit Sizes				Vanity Unit Codes, Colours & Prices					
		Width	Depth	Height	+Splash	Matt White		Sand		Olive	
						Code	Price	Code	Price	Code	Price
134 Curved wall-hung vanity unit & Minerva® White with vanity bowl	3 Door	134	55	51	59	FW4W +BW13	€2269	FW4S +BW13	€2269	FW4O +BW13 (A)	€2269
134 Curved wall-hung vanity unit & Minerva® Black Granite with vanity bowl	3 Door	134	55	51	59	FW4W +BB13	€2503	FW4S +BB13	€2503	FW4O +BB13 (B)	€2503
134 Curved wall-hung vanity unit & Minerva® Carrara White with vanity bowl	3 Door	134	55	51	59	FW4W +BC13	€2503	FW4S +BC13	€2503	FW4O +BC13 (C)	€2503
100 Curved wall-hung left handed vanity unit with drawer & Minerva® White with left hand vanity bowl	LH 2 Door	98	55	51	59	FW5W +BW98L	€1636	FW5S +BW98L	€1636	FW5O +BW98L (D)	€1636
100 Curved wall-hung left handed vanity unit with drawer & Minerva® Black Granite with left hand vanity bowl	LH 2 Door	98	55	51	59	FW5W +BB98L	€1753	FW5S +BB98L	€1753	FW5O +BB98L	€1753
100 Curved wall-hung left handed vanity unit with drawer & Minerva® Carrara White with left hand vanity bowl	LH 2 Door	98	55	51	59	FW5W +BC98L (E)	€1753	FW5S +BC98L	€1753	FW5O +BC98L	€1753
100 Curved wall-hung right handed vanity unit with doors & Minerva® White with right handed vanity bowl	RH 2 Door	98	55	51	59	FW6W +BW98R	€1636	FW6S +BW98R	€1636	FW6O +BW98R	€1636
100 Curved wall-hung right handed vanity unit with doors & Minerva® Black Granite with right handed vanity bowl	RH 2 Door	98	55	51	59	FW6W +BB98R	€1753	FW6S +BB98R (F)	€1753	FW6O +BB98R	€1753
100 Curved wall-hung right handed vanity unit with doors & Minerva® Carrara White with right hand vanity bowl	RH 2 Door	98	55	51	59	FW6W +BC98R	€1753	FW6S +BC98R	€1753	FW6O +BC98R	€1753



(D) Left hand

(E) Left hand

(F) Right hand

Fitted Furniture Example: 210cm Length Run

COLOUR: SAND

The Burlington fitted furniture collection is an ingenious system of individual units fitted together to give the illusion of space and maximise functionality in your bathroom. The uninterrupted straight lines accentuate the length of the interior and give a traditionally British feel.



60cm Mirrored double door wall unit (F6MS*) €410



60cm Double door wall unit (F6WS*) €351



60cm Basin base unit for semi recessed basin with semi recessed 58cm basin
Base Unit (F6BS*) €445
Basin (B12) €216



60cm Double door base unit
Base Unit (F6OS*) €410



60cm Back-to-wall WC unit with lever flush cistern
WC unit (W60S*) €422
WC Pan (P14) €258



30cm Tall unit two door base unit (F3TS*) €644



Burlington soft close seat, chrome hinge, Sand (S43) €116
Opposite;



Minerva® White 120cm worktop (BW305) €233



Minerva® Joint Kit White (MVWH) €59

F6MS	€410
F6WS x2	€702
F3TS	€644
F6BS	€445
B12	€216
F6OS	€410
W60S	€422
P14	€258
S43	€105
BW305 x2	€466
MNWH	£59

As shown €4132

Create a seamless feel with WC units and integrated basins semi-recessed into worktops and then fill your remaining space with low or tall storage units perfect for storing away the everyday bathroom clutter. Our bathroom configuration below is made up from the combination of base and wall units shown opposite.



Fitted Furniture Example: 150cm Length

COLOUR: MATT WHITE

All Burlington furniture pieces are made using a dowel and KD screw joining system for exceptional strength. And you can guarantee we've thought of everything for simple installation and sublime style. Cut out drawers allow for under-counter basin pipework without compromising on space. While spacious work surfaces, glass shelves and soft-close features add luxurious finishes that elevate your bathroom to one of superior quality. Our bathroom configuration opposite is made up from the combination of base and wall units below.



60cm Mirrored double door wall unit (F6MW) €410



30cm Single door wall unit (F3WW) €234



60cm Double door wall unit (F6WW) €351



Burlington soft close seat chrome hinge, Matt white (S45) €105



60cm Basin base unit for semi recessed basin with semi recessed 58cm basin
Base unit (F6BW) €445
Basin (B12) €216



30cm Single door base unit
Base unit (F3OW) €281



60cm Wall-hung WC unit with lever flush cistern
WC unit (W60W) €422
Wall-hung WC Pan (P10) €275
Steel frame (W33A) €164



Minerva® Carrara White 120cm Worktop (BC305) €350 each

Minerva® Joint Kit White (MVCA) €59

Opposite;

- F6MW €410
- F3WW €234
- F6WW €351
- S45 €105
- F6BW €445
- B12 €216
- F3OW €281
- W60W €305
- P10 €275
- W33A €164
- BC305 x 2 €700
- MVCA €59

As shown €3658

MINERVA® INFORMATION

Minerva® worktops are supplied with a template for mounting the Burlington semi recessed basin B12 - these are cut on site. The worktops can be extended with a seamless joint by using the Joint Kit (see p100) The lever flush cistern fittings have access from the front and the top for easy maintenance. The front panel of the WC unit is held on with magnets for easy access.

Minerva® worktops - Our stunning satin Minerva® Carrara White worktop placed on top of units provides an element of luxury with ultimate strength and superior finish. Cut and fit 120cm worktops together or extend your worktop using the joining kit, seamlessly polishing out joints for a flawless effect.



Wall Furniture



60cm Double door wall unit
W: 60, D: 15, H: 75
F6Wz*
€351



30cm Mirrored single door wall unit
W: 30, D: 15, H: 75
F3Mz*
€281



60cm Mirrored double door wall unit
W: 60, D: 15, H: 75
F6Mz*
€410



30cm Single door wall unit
W: 30, D: 15, H: 75
F3Wz*
€234

Floor Furniture



60cm Basin base unit for semi recessed basin with semi recessed 58cm basin

Unit: W: 60, D: 30, H: 85
Basin: W: 48, D: 58, H: 195
Base Unit F6Bz* €445
Basin B12 €216
Combined price €661



60cm Back-to-wall WC unit with lever flush cistern fittings and back-to-wall pan with white soft close seat - urea

Unit: W: 60, D: 30, H: 85
WC: W: 36.5, D: 48, H: 42
WC unit F6Wz* €422
WC Pan P14 €258
Seat S18 €105
Combined price €785



60cm Back-to-wall WC unit with lever flush cistern fittings and regal back-to-wall pan with white soft close seat - urea

Unit: W: 60, D: 30, H: 85
WC: W: 36.5, D: 48, H: 48
WC unit F6Wz* €422
Regal WC Pan P15 €315
Seat S18 €105
Combined price €842



60cm Double door base unit
W: 60, D: 30, H: 85
F60z* €410



Plumbing Cover - matt grey
W: 30, D: 15, H: 75
X02Gz* €82



30cm Single door base unit
W: 30, D: 30, H: 85
F30z* €281



30cm Tall two door base unit
W: 30, D: 30, H: 191
F3Tz* €644

Worktops



Minerva® White 120cm
W: 120, D: 30.5, H: 2.5
BW305 €233



Minerva® Black Granite 120cm
W: 120, D: 30.5, H: 2.5
BB305 €292



Minerva® Carrara White 120cm
W: 120, D: 30.5, H: 2.5
BC305 €350

Minerva® Joint Kit
See page 100
White MVWH €59
Black Granite MVBG €59
Carrara White MVCA €59

Mirrors

Our stunning mirrors come with or without LED lighting, which can add to the ambience of your bathroom. Perfect for applying make-up or grooming. The lights are activated with proximity switches. No need to touch a switch, a simple wave of the hand activates the lights surrounding your mirror.



Framed 60 mirror with LED illumination
W: 60, D: 4, H: 75
M6Mz* €467



Framed 90 mirror with LED illumination
W: 90, D: 4, H: 75
M9Mz* €584



Framed 90 mirror with LED illumination
W: 120, D: 4, H: 75
M12Mz* €701



Framed 60 mirror
W: 60, D: 4, H: 75
M60z* €233



Framed 90 mirror
W: 90, D: 4, H: 75
M90z* €327



Framed 120 mirror
W: 120, D: 4, H: 75
M120z* €409

INFORMATION

Dimensions & Technical Drawings:
Dimensional drawings and technical details are shown at burlingtonbathrooms.com/furniture



Tap holes:
Minerva® worktops are supplied with an integrated bowl with overflow, and no tap holes. Tap holes are drilled by the installer in the required position and configuration. A template is provided with the Minerva® tops indicating tap hole positions and sizes.

3 COLOURS
Sand, Matt White & Dark Olive



*To order the correct furniture colour simply remove the 'z' from the product code and replace it with:
S for Sand (ie FF8S)
O for Dark Olive (ie FF8O)
W for Matt White (ie FF8W)

WC Seats



Chrome Soft Close Sand Seat
S43 €105
with chrome handles
S43 + A51CHR €116



Chrome Soft Close Dark Olive Seat
S44 €105
with chrome handles
S44 + A51CHR €116



Chrome Soft Close Matt White Seat
S45 €105
with chrome handles
S45 + A51CHR €116

London Baths

Burlington Bathrooms now offer a new range of baths each with panels or surrounds in corresponding colours to your furniture, transforming your entire bathroom into a space of peace and tranquillity with a subtle, traditionally British feel.



HDP

The plinths of the free-standing furniture are crafted from HDP Polymer - a waterproof base providing extra protection and giving peace of mind that wet floors will not lead to damage.

London bath with curved surround including overflow & waste in matt white
L: 180, W: 85, H: 60
E22z* **€2105**

London bath is supplied with overflow and fitted waste. No tap holes possible on bath rim.



London back-to-wall bath with curved surround including overflow & waste in matt white
L: 180, W: 95, H: 60
E23z* **€2105**

London bath is supplied with overflow and fitted waste. Supplied with no tap holes, but these can be drilled into the furniture surround where appropriate.



3 COLOURS

Sand, Matt White & Dark Olive



*To order the correct furniture colour simply remove the 'z' from the product code and replace it with:
S for Sand (ie FF8S)
O for Dark Olive (ie FF8O)
W for Matt White (ie FF8W)

INFORMATION

Dimensions & Technical Drawings:
Dimensional drawings and technical details are shown at burlingtonbathrooms.com/baths

Tap holes:
The London bath is not suitable for deck-mounted taps. Floor mounted or wall mounted taps should be used.

Opposite above; London Bath with Sand Curved Surround including overflow & waste €2105, deck mounted Birkenhead bath shower mixer €603, Stand pipes including horizontal support bar €375.

Opposite below; London Back To Wall Bath with Dark Olive Curved Surround including overflow & waste €2105, deck mounted Claremont Regent bath shower mixer €650.



Baths & Panels

For those with limited space, the Arundel bath can be fitted in a recess (front only), in a corner (front and end), peninsular (two fronts one end) or island (all panels) configuration, giving you complete flexibility over the placement of your bath.



Arundel Cleargreen bath 170 x 70
L: 170, W: 70, H: 44
(including adjustable legs)
E28 **£467**

See page 124 for more details



Arundel Cleargreen bath 170 x 75
L: 170, W: 75, H: 44
(including adjustable legs)
E30 **£467**

See page 124 for more details



Arundel 170 bath side panel
L: 170, T: 1.8, H: 54
E24Fz* **£233**



Arundel 70 bath end panel
L: 68.2, T: 1.8, H: 54
E25Ez* **£151**



Arundel 75 bath end panel
L: 73.2, T: 1.8, H: 54
E26Ez* **£151**



INFORMATION

Dimensions & Technical Drawings:
Dimensional drawings and technical details are shown at burlingtonbathrooms.com/baths



Cleargreen Technology:
The Arundel Bath has a full steel frame and legs, with Cleargreen thermal insulation and reinforcement, as well as acoustic damping.

Bath Grips



Luxury bath grips (pair)
For use on all rectangular baths
D: 3, W: 27, H: 7
Weight: 1.9kg
Finish: Chrome
R30 **£70**



Standard bath grips (pair)
For use on all rectangular baths
D: 2, W: 22, H: 4
Weight: 0.4kg
Finish: Chrome
R37 **£29**

Bathscreens

You can create a shower over Arundel baths, with or without an access panel within the screen.

If combining a bathscreen and bath grips ask your local specialist about the positioning of the grips.

For bathscreens that can be used with Arundel baths see page 128

3 COLOURS

Sand, Matt White & Dark Olive



To order simply replace the 'z' at the end of the product code with S for Sand (ie E25ES), O for Dark Olive (ie E25EO) or W for Matt White (ie E25EW)

Minerva® Worktops

Minerva® worktops are available from stock in either pristine Minerva® White, elegant Minerva® Carrara White or opulent Minerva® Black Granite.

You can choose from our other 9 unique décor options, available to order with longer custom delivery times for the ultimate personalised look, ask your local specialist Burlington dealer.



Minor Scratching

Scratches to the work surface will be more evident on darker colours. Any minor scratches can be removed using a woven abrasive pad and other items in the care kit.



Staining

Minerva®, unlike marble and granite, is not porous and will resist most household chemicals including alcohol and cosmetics, however, some chemicals and strong dyes can cause damage and discolouration. If spillage occurs, wipe off immediately and rinse the area thoroughly.



Routine Cleaning

Minerva® does not require any specialist cleaning regimes, most dirt and light residue will easily wipe off with a damp cloth and soapy water. The work surface should then be rinsed with clean water and wiped dry. Persistent marks can be removed by using a mild abrasive cleaner, but harsh scouring powders should be avoided.



Minerva® Care Kit

To restore your Minerva® worktop to its original best use the Care Kit to buff out all tiny scratches and scuffs. The kit contains all the sanding / buffing materials and liquids required.

Paint Your Own

Should you wish, our Matt White furniture is supplied ready for you to paint, so you can transform your entire bathroom to your individual colour scheme. We've chosen some Farrow & Ball colours as suggestions displayed below. We recommend using a water based primer before an egg shell emulsion for the best effect.

Before



After



Minerva® Joint Kit
 White MVWH **£59**
 Black Granite MVBG **£59**
 Carrara White MVCA **£59**



Minerva® Care Kit
 BCARE **£59**



120cm Minerva® Worktops
 White BW305 **£233**
 Black Granite BB305 **£292**
 Carrara White BC305 **£350**



Pelt



Brassica



Vert De Terre



Cook's Blue

Bathing

The Burlington range of free-standing baths offers beautifully crafted exclusivity in a variety of styles to suit both modern and traditional spaces. Choose from soaking tubs, exclusive traditional baths with a range of feet in six styles and three colours to personalise your bath to your individual tastes and bathroom décor. All the baths are made using the highest quality techniques and processes to ensure the finished product will provide many years of blissful bathing. There are three exceptional Natural Stone baths for that extra piece of luxury in your bathroom. For the ultimate in vintage bathroom design, select the unique Fire Hydrant waste system. See page 148 for more information. Whichever bath from our extensive range you choose, you are assured of the finest quality.



Blandford bath with luxury chrome claw feet €2335 and Claremont deck-mounted bath shower mixer €603, Decorative shrouds €268, and exposed chrome waste and overflow €151, P-trap €47 and P-trap connection pipe €116.

See page 116 for technical details on the Blandford bath.



BLANDFORD *Natural Stone* Divine roll top bath with adjustable legs, you can fine-tune your beautiful bath to your individual taste. Pair with centrally deck-mounted taps for a truly relaxing bathe without brassware to obstruct you.

For feet options see pages 130.

CHANDLER *Natural Stone* The sloping curves and rolled edges of this outstanding traditional bath make this product a true focal point in any bathroom. Customise with adjustable legs in a range of styles and colours.



Chandler bath with standard period chrome feet €2206 and Claremont deck-mounted bath shower mixer €603, decorative shrouds €268, and exposed chrome waste and overflow €151, P-trap €47 and P-trap connection pipe €116.
See page 116 for technical details on the Chandler bath.

WINDSOR The Windsor bath is a gorgeous example of a traditional roll top bath with perfectly formed curved and flowing lines. Being double-ended with gradually sloping sides it allows for luxurious bathing. Windsor baths are available in 150cm and 170cm.

For feet options see page 130.

Windsor 170cm bath with luxury chrome claw feet €912 and Claremont deck-mounted angled bath shower mixer €603, decorative shrouds €268, exposed chrome waste and overflow €151, P-trap €47 and P-trap connection pipe €116.

See page 116 for technical details on the Windsor bath.





BRINDLEY This graceful tub is an elegant addition to any bathroom and provides the perfect excuse for a leisurely soak. Its smooth curves, paired with traditional brassware for subtle style, will enhance any setting.

Brindley soaking tub and skirt €1052 with Clarendon floor-standing bath shower mixer €977, plug and chain waste €75.

See page 117 for technical details on the Brindley bath.



LONDON RECTANGULAR Make a statement with the London Rectangular, shown here primed and painted in silver to create the perfect centrepiece to a stunning bathroom. Its grand structure allows for generous internal capacity, allowing for comfort as well as style.

London rectangular soaking tub €1638 with Claremont floor-standing bath shower mixer €977. See page 117 for technical details on the London rectangular bath.

* The London Rectangular bath comes in a white finish, as show opposite. The exterior can be primed and painted. The photograph shows the bath painted in Craig & Rose paint in Sensual Silver. If you wish to paint yours then please note this is only possible on TSFR baths (not Natural Stone), you should seek advice from the paint manufacturer for suitable primers and process.



LONDON ROUND The double-ended London Round has a simple purity of form that will enhance any style of décor in your home. Shown here paired with traditional brassware for a timeless aesthetic.

London round soaking tub €1638 with Claremont floor-standing bath shower mixer €977.

See page 117 for technical details on the London round bath.



ADMIRAL 180 & 165 This stunning, dramatic bath will provide a gorgeous centrepiece in any bathroom. Its grand appearance and imposing structure deserves to be the centre of attention. The Admiral bath also comes in two sizes, a 180cm length and a 165cm for reduced space.

Admiral 180cm bath €2105 with Birkenhead floor-standing bath shower mixer €977 and exposed chrome waste and overflow €151.

See page 117 for technical details on the Admiral bath.

Double-ended baths

BLANDFORD



Blandford Natural Stone Bath
with chrome luxury feet

Length	Width	Height	Bath Code	Price	Standard legs	Luxury Legs
170cm	80cm	67cm	EN9	€2055	€151	€280

Material	Natural Stone
Bath water capacity	232 litres (162 litres displaced water capacity)
Weight empty	93 Kg
Compatible wastes	CW2, CW3, W4, W21
Tap Hole Options	0, 1, 2 (supplied with template, undrilled)
Overflow	Supplied with template, undrilled
Feet Options	See pages 130 & 131 (bath shown with L1C legs)

CHANDLER



Chandler Natural Stone Bath
with chrome luxury feet

Length	Width	Height	Bath Code	Price	Standard legs	Luxury Legs
170cm	80cm	67cm	EN10	€2045	€151	€280

Material	Natural Stone
Bath water capacity	232 litres (162 litres displaced water capacity)
Weight empty	93 Kg
Compatible wastes	CW2, CW3, W4, W21
Tap Hole Options	0, 1, 2 (supplied with template, undrilled)
Overflow	Supplied with template, undrilled
Feet options	See pages 130 & 131 (bath shown with L2C legs)

BRINDLEY



Brindley soaking tub with surround

Length	Width	Height	Bath Code	Price
170cm	75cm	67cm	E5.E12	€1052

Material	TSFR
Bath water capacity	250 litres (180 litres displaced water capacity)
Weight empty	34Kg
Compatible wastes	CW2, W3
Tap Hole Options	Not suitable for rim mounted taps
Overflow	Supplied with template, undrilled

LONDON RECTANGULAR



London rectangular soaking tub

Length	Width	Height	Bath Code	Price
180cm	85cm	64cm	E19	€1638

Material	TSFR
Bath water capacity	290 litres (220 litres displaced water capacity)
Weight empty	45Kg
Compatible wastes	Pre fitted with a waste
Tap Hole Options	Not suitable for rim mounted taps
Overflow	Pre-drilled

WINDSOR 150 & 170



Windsor Double ended 150cm bath
with chrome luxury claw feet

Length	Width	Height	Bath Code	Price	Standard legs	Luxury Legs
150cm	75cm	63cm	E4	€632	€151	€280
170cm	75cm	63cm	E4	€632	€151	€280

Material	TSFR
Bath water capacity	185 / 200 litres (115 litres displaced water capacity)
Weight empty	45Kg / 47Kg
Compatible wastes	CW2, CW3, W4, W21, W8N
Tap Hole Options	0, 1, 2 (supplied with template, undrilled)
Overflow	Supplied with template, undrilled
Feet Options	See pages 130 & 131 (bath shown with L1C legs)

BATEAU



Bateau Double ended 170cm bath
with chrome luxury feet

Length	Width	Height	Bath Code	Price	Standard legs	Luxury Legs
164cm	70cm	72cm	T10F	€1169	€151	€280

Material	TSFR
Bath water capacity	99 litres (169 litres displaced water capacity)
Weight empty	42Kg
Compatible wastes	CW3, W4, CW6, W21
Tap Hole Options	Not suitable for rim mounted taps
Overflow	Pre-drilled
Feet Options	See pages 130 & 131 (bath shown with L2C legs)

ADMIRAL 165 & 180



Admiral soaking tub

Length	Width	Height	Bath Code	Price
165cm	71cm	71cm	ET5C	€1754
180cm	89cm	75cm	ET6C	€2105

Material	TSFR
Bath water capacity	169 / 245 litres (99 / 175 litres displaced water capacity)
Weight empty	45Kg / 60Kg
Compatible wastes	CW3, W4, CW6
Tap Hole Options	Not suitable for rim mounted taps
Overflow	Pre-drilled

LONDON ROUND



London round soaking tub

Length	Width	Height	Bath Code	Price
180cm	85cm	64cm	E18	€1638

Material	TSFR
Bath water capacity	270 litres (200 litres displaced water capacity)
Weight empty	45Kg
Compatible wastes	Pre fitted with a waste
Tap Hole Options	Not suitable for rim mounted taps
Overflow	Pre-drilled

HANOVER *Natural Stone* With an elegant graduating slope crafted at the perfect angle for a relaxing bathe, the Hanover is a firm favourite. Shown here with beautiful chrome classic feet.

For feet options see pages 130–131.

Hanover bath with luxury chrome classic feet €2335 and Claremont deck-mounted bath shower mixer €603, decorative shrouds €268, and exposed chrome waste and overflow €151, P-trap €47 and P-trap connection pipe €116.

See page 124 for technical details on the Hanover bath.



BLENHEIM An elegant and simple shape providing timeless design and beautiful aesthetic. A classic addition to any traditionally styled bathroom. Keep simple with stylish feet in a chrome finish for a seamless and subtle look.

For feet options see page 130.

Blenheim single ended with standard classical legs €772, Birkenhead deck-mounted bath shower mixer €603, decorative shrouds €268, exposed chrome waste and overflow €151, P-trap €47 and P-trap connection pipe €116.

See page 124 for technical details on the Blenheim bath.

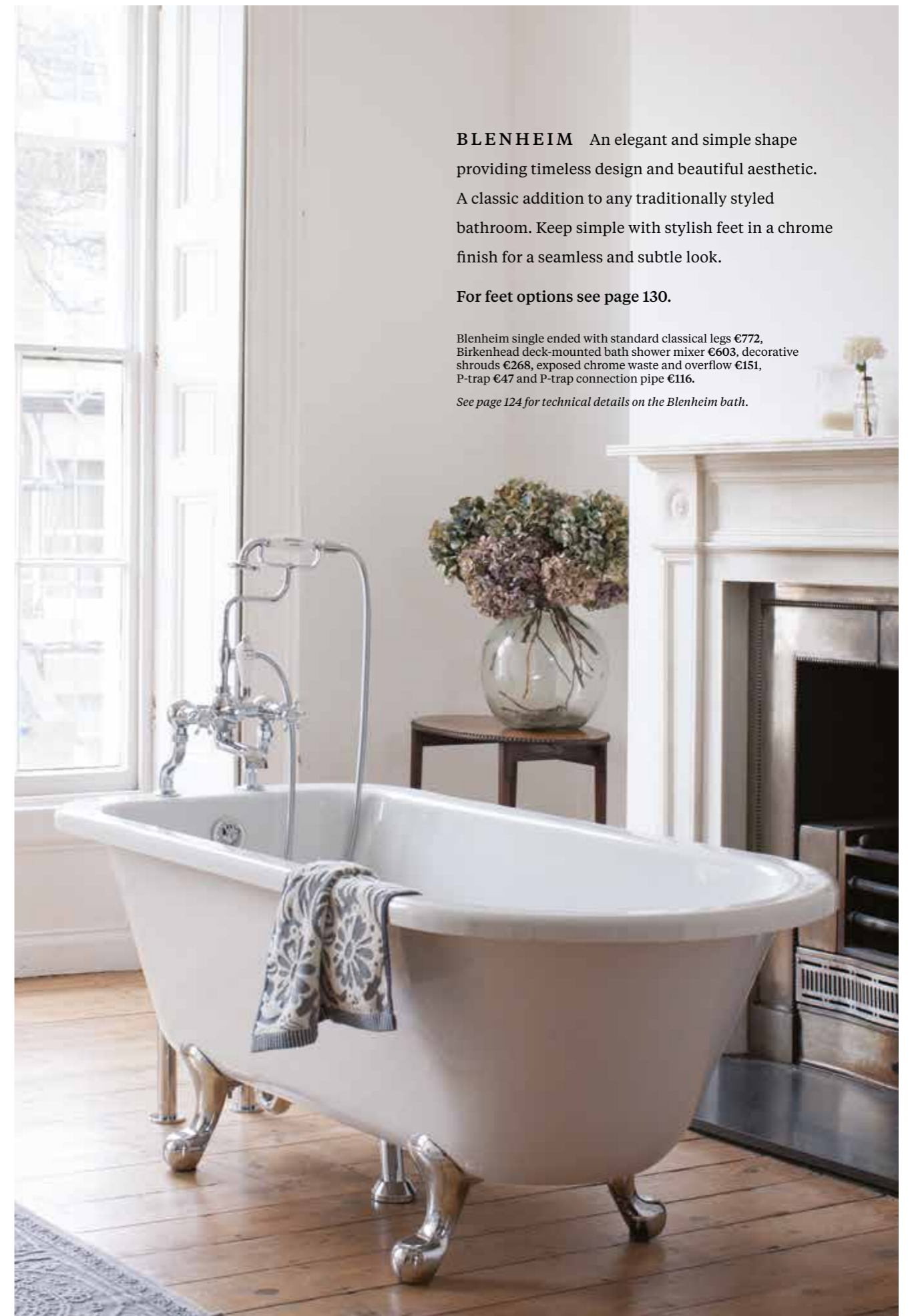

BUCKINGHAM The Buckingham is a simple and stylish example of the slipper bath, with its raised end angled perfectly to support you for the ultimate comfortable bathe. Shown here with an optional Fire Hydrant waste.

For feet options see page 130.

Buckingham bath with luxury white arc feet €912, Claremont angled deck-mounted bath shower mixer €603 with decorative shrouds €268 and Fire Hydrant €1169.

See page 125 for technical details on the Buckingham bath.



FIRE HYDRANT ↑

Design a bathroom to suit your specific needs
View more information about Fire Hydrant on page 148

Burlington incorporates a distinctive free-standing waste system that operates from the plug hole. The Fire Hydrant is an elegant option for all baths with no pre-drilled overflow hole. Water fills the hydrant which incorporates a built in overflow and plug system, simply lift the handle to empty your bath. This innovative waste system with beautiful traditional handles adds a level of opulence to your bathroom.



EMPEROR A tall and impressive bath; the emperor has a deep, regal stature which will act as a showpiece in your bathroom, yet its angled internal base also provides exceptional comfort and support for a tranquil bathe.

Emperor bath €1754 with Claremont floor-standing bath shower mixer €977, and click-clack waste €39.
See page 125 for technical details on the Emperor bath.



HAREWOOD The raised end of this stunning slipper bath is angled perfectly to support you and provide a luxurious bathe. Pair with beautifully traditional brassware and optional decorative shrouds for a unified classic look.
For feet options see page 130.

Harewood bath with standard chrome traditional legs €912 with Anglesey deck-mounted bath shower mixer €603 with decorative shrouds €268 and Fire Hydrant €1169.
See page 125 for technical details on the Harewood bath.

Single-ended baths

HANOVER



Hanover Natural Stone Bath
with chrome luxury classic feet

Length	Width	Height	Bath Code	Price	Standard legs	Luxury Legs
170cm	75cm	80cm	EN11	£2055	£151	£280

Material	Natural Stone
Bath water capacity	247 litres (177 litres displaced water capacity)
Weight empty	90Kg
Compatible wastes	CW2, CW3, W4, W21
Tap Hole Options	0, 1, 2 (supplied with template, undrilled)
Overflow	Supplied with template, undrilled
Feet Options	See pages 130-131 (bath shown with L3C legs)

BLLENHEIM



Blenheim single ended bath
with chrome luxury classic feet

Length	Width	Height	Bath Code	Price	Standard legs	Luxury Legs
170cm	75cm	64cm	E2	£620	£151	£280

Material	TSFR
Bath water capacity	185 litres (115 litres displaced water capacity)
Weight empty	45Kg
Compatible wastes	CW2, CW3, W4, W21, W8N
Tap Hole Options	0, 1, 2 (supplied with template, undrilled)
Overflow	Supplied with template, undrilled
Feet Options	See pages 130-131 (bath shown with L3C legs)

ARUNDEL CLEARGREEN



Arundel Cleargreen Bath

Length	Width	Height	Bath Code	Price
170cm	70cm	58cm	E28	£467

Material	Lucite / CG
Bath water capacity	178 litres (108 litres displaced water capacity)
Weight empty	24Kg
Compatible wastes	W4
Compatible bathscreens	C9, C10
Compatible bath grips	R30, R37
Tap Hole Options	Undrilled
Overflow	Overflow hole is predrilled
Bath panels	E24FW, E24FO, E24FS, E25EW, E25EO, E25ES See page 99

ARUNDEL CLEARGREEN



Arundel Cleargreen Bath

Length	Width	Height	Bath Code	Price
170cm	75cm	58cm	E30	£467

Material	Lucite / CG
Bath water capacity	195 litres (125 litres displaced water capacity)
Weight empty	25Kg
Compatible wastes	W4
Compatible bathscreens	C9, C10
Compatible bath grips	R30, R37
Tap Hole Options	Undrilled
Overflow	Overflow hole is predrilled
Bath panels	E24FW, E24FO, E24FS, E26EW, E26EO, E26ES See page 99

Single & Double-ended baths

BUCKINGHAM / HAREWOOD



Buckingham 150cm, Harewood 170cm slipper bath
with chrome luxury classic feet

Length	Width	Height	Bath Code	Price	Standard legs	Luxury Legs
150cm	74cm	63cm	E6	£632	£151	£280
170cm	74cm	63cm	E1	£632	£151	£280

Material	TSFR
Bath water capacity	155 / 195 litres (85 / 125 litres displaced water capacity)
Weight empty	39Kg / 48Kg
Compatible wastes	CW2, CW3, W4, W21, W8N
Tap Hole Options	0, 1, 2 (supplied with template, undrilled)
Overflow	Supplied with template, undrilled
Legs	See pages 130-131 (bath shown with L3C legs)

EMPEROR



Emperor bath

Length	Width	Height	Bath Code	Price
153cm	73cm	78cm	ET13B	£1754

Material	TSFR
Bath water capacity	312 litres (242 litres displaced water capacity)
Weight empty	38Kg
Compatible wastes	CW2, CW3, W4, CW6, W21
Tap Hole Options	Not suitable for rim mounted taps
Overflow	Supplied with template, undrilled

HEART



Heart Bath

Length	Width	Height	Bath Code	Price
163cm	133cm	58cm	T11F	£1637

Material	TSFR
Bath water capacity	155 litres (225 litres displaced water capacity)
Weight empty	45Kg
Compatible wastes	CW3, W4, CW6, W21
Tap Hole Options	0, 1, 2 (supplied with template, undrilled)
Overflow	Overflow hole is predrilled
Legs	See pages 130-131 (bath shown with L1C legs)

AVANTGARDE



Avantgarde Bath

Length	Width	Height	Bath Code	Price
170cm	75cm	63cm	T12D	£1052

Material	TSFR
Bath water capacity	158 litres (228 litres displaced water capacity)
Weight empty	37Kg
Compatible wastes	CW2, CW3, W4, CW6, W21
Tap Hole Options	0, 1, 2 (supplied with template, undrilled)
Overflow	Supplied with template, undrilled
Legs	See pages 130-131 (bath shown with L1C legs)

Showering Over a Bath

The Hampton showering bath is available in either right or left hand options and gives great flexibility to those who may wish to have both bathing and showering options available to them. Simply place into a corner and pair with our innovative bath screen with access panel, allowing you to turn on the shower, before getting in, without getting wet.



BATHSCREEN WITH ACCESS PANEL

Easy access panel, allows you to turn on the shower without getting wet.
See page 128 for details.



Showering Baths



On all Burlington baths
See website for details

HAMPTON LEFT HANDED



Hampton Left Handed Bath
with chrome luxury classic feet

Length	Width	Height	Bath Code	Price	Standard legs	Luxury Legs
150cm	75cm	65cm	E20	€609	€151	€280
170cm	75cm	65cm	E13	€632	€151	€280

Compatible wastes CW8N, W4, CW2, CW3,W21
Compatible shower screens C9, C10
Tap Hole Options 0, 1, 2 (supplied with template, undrilled)
Overflow Supplied with template, undrilled
Feet options See pages 130 & 131 (Shown with L3C legs)

HAMPTON RIGHT HANDED



Hampton Right Handed Bath
with chrome luxury classic feet

Length	Width	Height	Bath Code	Price	Standard legs	Luxury Legs
150cm	75cm	65cm	E21	€609	€151	€280
170cm	75cm	65cm	E14	€632	€151	€280

Compatible wastes CW8N, W4, CW2, CW3,W21
Compatible shower screens C9, C10
Tap Hole Options 0, 1, 2 (supplied with template, undrilled)
Overflow Supplied with template, undrilled
Feet options See pages 130 & 131 (Shown with L3C legs)

BATHSCREEN WITH ACCESS PANEL



Width	Height	Screen Code	Price
85cm	145cm	C10	€526

Compatible baths E20, E21, E13, E14, E28, E30
3 tm coating Glass resists stain so is easier to clean
3M® Glass 8mm safety glass

SINGLE BATHSCREEN



Width	Height	Screen Code	Price
85cm	145cm	C9	€385

Compatible baths E20, E21, E13, E14, E28, E30
3 tm coating Glass resists stain so is easier to clean
3M® Glass 8mm safety glass



Prices exclude VAT

Luxury Bath Feet

Chrome



White



Black



Claw Feet

	Chrome	White	Black
Code:	L1C	L1W	L1B
Price:	€280	€280	€280



Arc Feet

	Chrome	White	Black
Code:	L2C	L2W	L2B
Price:	€280	€280	€280



Classic Feet

	Chrome	White	Black
Code:	L3C	L3W	L3B
Price:	€280	€280	€280



Standard Bath Feet

Chrome



White



Black



Traditional Feet

	Chrome	White	Black
Code:	E11 CHR	E11 WHI	E11 BLA
Price:	€151	€151	€151



Classical Feet

	Chrome	White	Black
Code:	E10 CHR	E10 WHI	E10 BLA
Price:	€151	€151	€151



Period Feet

	Chrome	White	Black
Code:	E9 CHR	E9 WHI	E9 BLA
Price:	€151	€151	€151



BATH FEET

Available with all Burlington roll top baths

Many Burlington baths have the flexibility for adjustable feet, meaning you can customise your beautiful bath with a range of styles and colours as shown to the left. Each of these come in Chrome, Black or White.



Brassware

The Brassware is packed full of innovative technology, not seen amongst other traditional competitors. Every Burlington tap is supplied with a flow straightener for areas with low water pressure and an aerator for areas with high water pressure. This, unlike most traditional taps, ensures your water is delivered at 13 litres per minute regardless of incoming water pressure. So you no longer have to cope with water splashing everywhere, the flow from a Burlington tap is perfect every time.

All bath fillers and bath shower mixers have rotating spouts so you can move the brassware out of the way to enjoy a relaxing bathe. Every bath shower mixer also comes with an 'S' Adjuster, allowing you to position the handset over the bath. You can install your bath shower mixer with or without this feature. All are also available as an angled option, so you see the indices when you walk into the room. Bridge basin mixer spouts also swivel to allow you to turn your tap into a drinking fountain.





TAPS & BRASSWARE

Classic Basin with Invisible overflow. See page 20 for more details.



TAPS & BRASSWARE

Burlington Taps

Water saving is becoming part of our lives.

Burlington is the first British Traditional Designed range available that enables water savings! The clever part in the taps is called an aerator. We believe that the finest manufacturer of aerators is the Swiss manufacturer called Neoperl. So we only use Neoperl.

In the UK some homes have low water pressure and some have high water pressure. We supply every tap with two Neoperl devices: A flow straightener which is for use with low water pressures and an aerator which is for use with high water pressures, so you can set up your tap correctly every time!

Our taps are designed to deliver the following maximum flows of water, regardless of the incoming water pressure:

- Basin taps 13 litres per minute
- Bath tap 14 litres per minute
- Bath shower mixer 22 litres per minute

So you can have fabulous performance whilst limiting the damage to our planet.

NORMAL SPOUT

The underside of a bath spout of a normal, traditional bath tap.



BURLINGTON SPOUT

The underside of a Burlington bath tap with a Neoperl aerator.



NORMAL TAP

Water flow in a normal traditional tap

LOW PRESSURE

Low pressure water flow with a Burlington tap using a flow straightener

HIGH PRESSURE

High pressure water flow with a Burlington tap using an aerator



SWIVELLING SPOUTS

All our Bath Fillers and Bath Shower Mixer spouts swivel - so you don't have the spout in your way when you shower (and if two of you bathe together the unlucky one doesn't have a spout sticking in their back!!)

ANGLED MIXERS

All our Bath Fillers and Bath Shower Mixers are available in an "angled" version. Now you can see your bath taps at the correct angle when you walk into your bathroom!

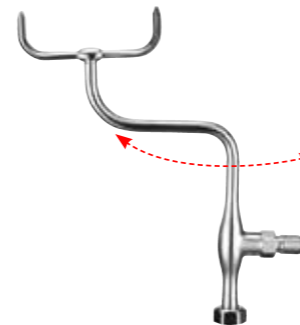
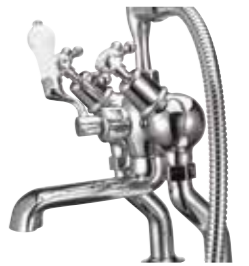

'S' ADJUSTERS

Every Bath Shower Mixer comes with our "S Adjuster". This means you can position the telephone handset over the bath - so when you are done it drips into the bath! You can swivel the "S Adjuster" parallel to the wall too! You can install your Bath Shower Mixer with or without the "S Adjuster".

BRIDGE MIXERS

Our Bridge Basin Mixer allows you to have mixed hot & cold water, whilst using a two taphole configuration. The spout swivels too...

- Straight down
- 90° left or right
- Straight up

- Normal basin mixer
- Off
- Drinking fountain!

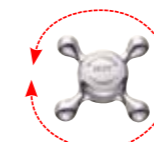
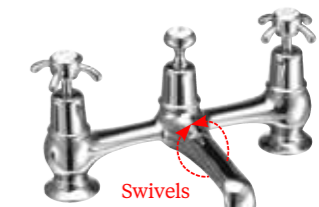

Traditional screw-down



Quarter turn

VALVE OPTIONS

All Burlington taps are available with traditional screw-down valves or with quarter-turn valves. The taps work with both low and high pressure. See "technical PDF" for each tap on our website for specific flow rates.



TAPS & BRASSWARE

TAPS & BRASSWARE



On all brassware
See website for details

Claremont Deck Mounted Bath Shower Mixer with Handset "S" adjuster.



Burlington Taps

Eight Ranges

CLAREMONT TAPS

A classic favorite from Burlington. This simple range of tap heads suits all basin, bath and bidet taps in the Burlington range. Pair with a deck mounted bath shower mixer for classical styling.



CLAREMONT REGENT TAPS

If looking for a little extra when choosing your brassware, opt for the regent range. A shapely stylish base suitable for all one, two and three tap hole taps excluding Chelsea and Stafford.



ANGLESEY TAPS

Pair the Anglesey tap head range with our Burlington contemporary range of basins.



ANGLESEY REGENT TAPS

The Anglesey is also available with the regent tap base to offer extra height to your tap. Pair with any of the Burlington basins.

BIRKENHEAD TAPS

The Birkenhead taps work well with any of our basins or baths and look particularly beautiful on our range of classic baths.



BIRKENHEAD REGENT TAPS

Also available with the regent option in the Birkenhead tap head. For something striking in your bathroom, this is the perfect choice.



KENSINGTON TAPS

Burlington's Kensington range of tap heads offers opulence and sophistication. Taking inspiration from a bygone era the Kensington brings a traditional style with modern technology.



KENSINGTON REGENT TAPS

Add the regent base to this tap style for an extravagant appearance - particularly suited to the Edwardian basins.

ORDERING YOUR TAPS

When ordering your taps add the correct code to the start of the tap code

Anglesey add AN
Claremont add CL
Birkenhead add BI
Kensington add KE

QUARTER turn

All our taps (except Kensington) come with the traditional screw down valves as standard.

For 'Quarter Turn' simply add 'QT' to the product code.

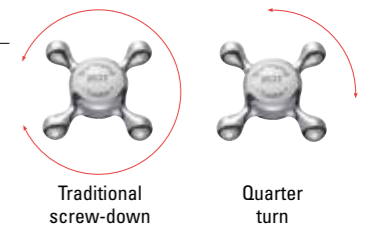

Traditional screw-down

Quarter turn

Burlington Basin Taps

ONE TAP HOLE



Basin mixer with high central indice with click-clack waste
CL6 **€265**

Regent
CLR6 **€288**



Basin mixer with high central indice with pop-up waste
CL4 **€239**

Regent
CLR4 **€263**



Basin mixer with high central indice with plug and chain waste
CL5 **€239**

Regent
CLR5 **€263**

TWO TAP HOLE



Basin tap 3"
CL1 **€140**

Regent
CLR1 **€187**



Basin tap 5"
CL2 **€151**

Regent
CLR2 **€198**



2 tap hole Bridge mixer with swiveling spout with plug and chain waste
CL10 **€361**

Regent
CLR10 **€405**



2 tap hole Arch mixer with curved spout (200mm centres)
CL27 **€339**

Regent
CLR27 **€385**

THREE TAP HOLE



3 tap hole mixer with pop-up waste
CL12 **€315**

Regent
CLR12 **€385**



3 tap hole thermostatic mixer with pop-up waste
T26+T1 **€397**

Regent
CLR12 **€385**



2 tap hole Arch mixer with curved spout (230mm centres)
CL28 **€339**

Regent
CLR28 **€385**

Victorian 61cm 2 tap hole basin and pedestal €229 with Claremont 5" pillar taps €151, plug and chain waste €17, rectangular mirror €233 and soap dish €41.

See pages 104 for technical details on the Victorian basin.



On all brassware
See website for details

Claremont Deck Mounted Bath Shower Mixer with Handset "S" adjuster.



Burlington Bath Taps

DECK MOUNTED



Bath shower mixer deck mounted with "S" adjuster
CL15 **€603**

Regent
CLR15 **€650**



Angled Bath shower mixer deck-mounted with "S" adjuster
CL19 **€603**

Regent
CLR19 **€650**



NEW

Thermostatic bath shower mixer deck mounted with "S" adjuster
T2DB **€935**

Regent
T2DBR **€982**



Bath filler deck-mounted
CL23 **€391**

Regent
CLR23 **€438**



Angled bath filler deck-mounted
CL25 **€391**

Regent
CLR25 **€438**



Bath tap deck-mounted
CL3 **€182**

Regent
CLR3 **€229**

WALL MOUNTED



Bath shower mixer wall mounted with "S" adjuster
CL17 **€603**

Regent
CLR17 **€650**



Angled bath shower mixer wall-mounted with "S" adjuster
CL21 **€603**

Regent
CLR21 **€650**



Bath filler wall-mounted
CL24 **€391**

Regent
CLR24 **€438**



Angled bath filler wall-mounted
CL26 **€391**

Regent
CLR26 **€438**

TAPS & BRASSWARE

TAPS & BRASSWARE

Thermostatic

NEW



Now, for the first time ever, you can have a traditional thermostatically controlled basin tap!

Now you can match your basin, bath and shower - all with the convenience and safety of thermostatic controls!



3 tap hole thermostatic mixer with pop-up waste
T26+T1 **€397**



Bath shower mixer deck mounted with "S" adjuster
T2DB **€935**

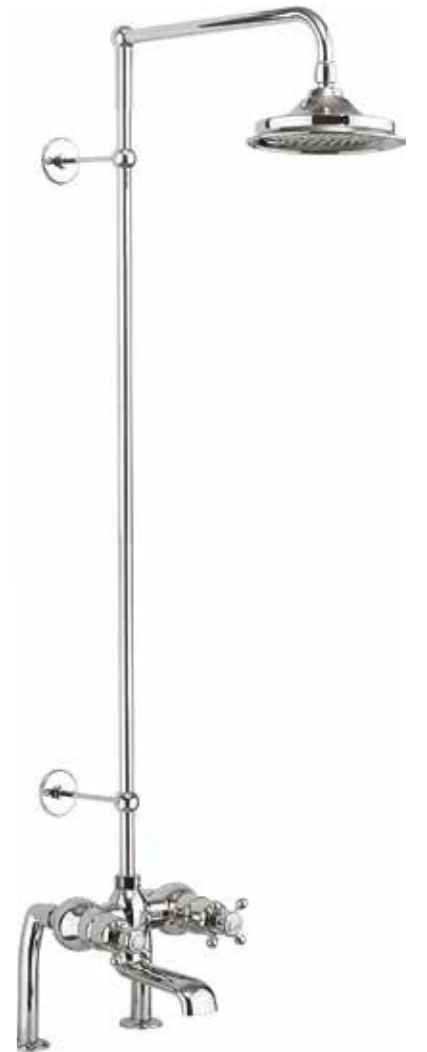

Thermostatic two outlet twin control bath shower mixer valve.
BT2DS + V16 **€1286**

Edwardian 61cm basin with standard pedestal €229 and Claremont 3 tap hole thermostatic mixer with pop-up waste €397.

See page 30 for technical details on the Edwardian basins collection.

TAPS & BRASSWARE

TAPS & BRASSWARE



Stafford

STAFFORD
A unique tap design

The Stafford offers basin and bath taps or bath shower mixers for an alternative bathroom design. Stafford is not available in quarter-turn.



Stafford Bath Pillar Taps
Including the handles
STA13 **€99**



Stafford Long Nose Basin Pillar Taps
Including the handles
STA12 **€87**



Stafford Mono Basin Mixer
with pop up waste
Including the handles
STA11 **€163**



Stafford Bath Shower Mixer
Deck mounted
Including the handles
(The Stafford does not include an "S" adjuster)
STA14 **€292**

Chelsea



Chelsea Curved Basin Mixer
with pop up waste
CH22 **€233**



Chelsea Curved Basin Mixer
without waste
CH21 **€210**



Chelsea Curved Bidet Mixer
with pop up waste
CH23 **€210**



Chelsea Straight Basin Mixer
without waste
CH19 **€210**



Chelsea Straight Basin Mixer
with pop up waste
CH20 **€233**



Chelsea Straight Tall Basin Mixer
without waste
CHE1 **€268**



Chelsea Curved Tall Basin Mixer
without waste
CHE2 **€268**



On all brassware
See website for details

Fire Hydrant for the ultimate traditional look

Traditional Fire Hydrant
Single ended baths. Supplied
with extension and P-trap waste
& extension
D: 80, W: 12, H: 70
W8N **€1168**

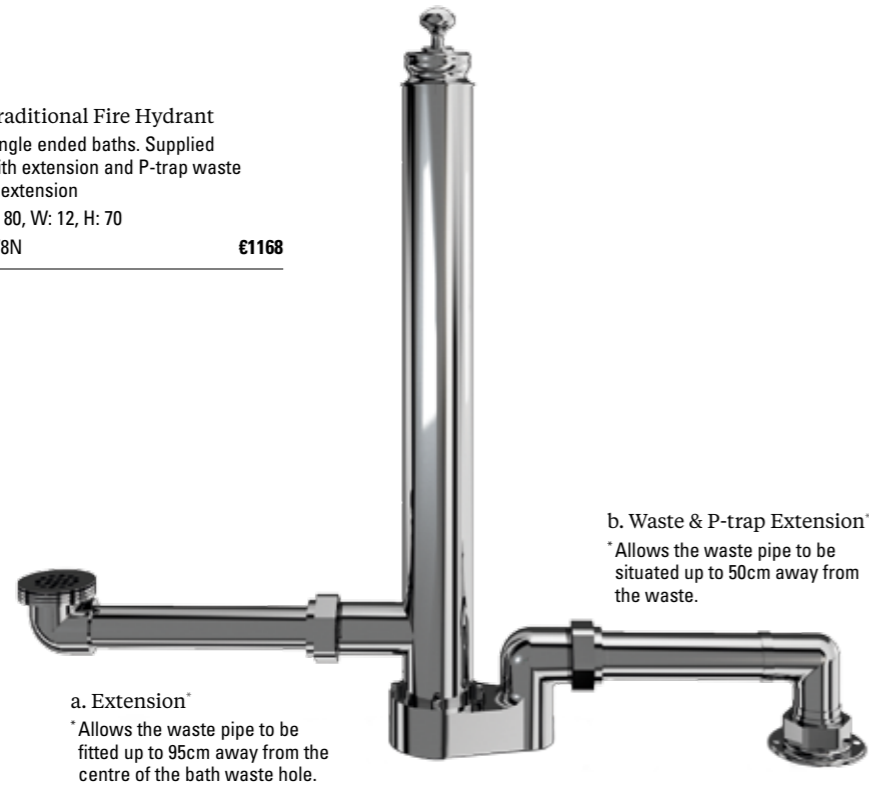

a. Extension*
*Allows the waste pipe to be
fitted up to 95cm away from the
centre of the bath waste hole.

b. Waste & P-trap Extension*
*Allows the waste pipe to be
situated up to 50cm away from
the waste.

Technology

Named Fire Hydrant due to its classic design, this is a very distinctive waste system that operates from the plug hole. Water fills the hydrant which incorporates a built in overflow and plug system, simply lift the handle to empty your bath. This waste system adds a level of opulence to your bathroom. Shown on page 80 on the Buckingham bath.

The waste pipe in our 'Fire Hydrant' is designed so that you can change the angles to fit into your waste in the floor.

Fire Hydrants can be used in a free-standing position.

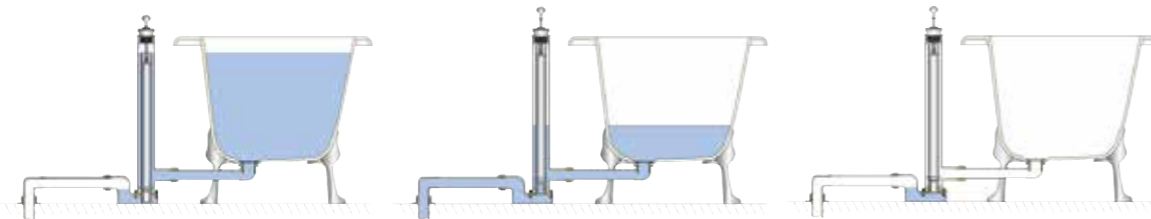

Full bath using overflow

Emptying bath

Empty bath



FIRE HYDRANT ↑

Design a bathroom to suit your specific needs
View more information about Fire Hydrant opposite or visit
www.burlingtonbathrooms.com

Burlington incorporates a distinctive free-standing waste system that operates from the plug hole. The Fire Hydrant is an elegant option for all baths with no pre-drilled overflow hole. Water fills the hydrant which incorporates a built in overflow and plug system, simply lift the handle to empty your bath. This innovative waste system with beautiful traditional handles adds a level of opulence to your bathroom.

Shrouds



Stand pipes including horizontal support bar
 These are for use with baths where fittings are not rim or wall-mounted (Water runs through the pipes). Can be used with deck-mounted taps.
 D: 10, W: 28, H: 60
 W7 **€375**

Stand Pipes



Decorative shrouds
 These are for use with baths with rim-mounted fittings and can be used with deck-mounted taps.
 D: 7, W: 7, H: 71
 W6 **€268**

for Baths



Shallow
P trap
CW3 **€47**

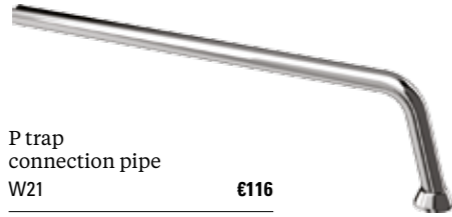

P trap
connection pipe
W21 **€116**



Exposed bath overflow, plug
& chain
W4 **€151**



Overflow filler
for single ended baths
W15 **€140**



Overflow filler
for double ended baths
W2 **€128**



Bath overflow,
plug & chain
W3 **€75**

for Bidets



Bidet
trap
W27 **€34**

for Basins



Flat bottom
bottle trap
W13 **€99**



Traditional
bottle trap
W14 **€46**



Flip top basin waste, slotted
Chrome
W18 **€26**



Tap hole stopper
Chrome
A49 CHR **€23**



'Click-clack' (push button)
basin waste
W11 **€26**



Basin plug & chain
(slotted)
W1 **€17**



Surface mounted soap
dispenser
Chrome (can be mounted
through a ceramic basin tap hole
or a work surface)
L: 11cm, W: 7cm, D: 7cm
A48 CHR **€105**

For Classic invisible waste & overflow see page 20 & 21

for WCs



Cistern tank
on/off valve
W25 **€39**



Angled connector for
telephone handset
Chrome
V62 **€23**

Showers

The Burlington range of showers provides extensive options so you can create a showering solution for your own bespoke setting. Whether you prefer showering over a bath or in an enclosure, Burlington has a solution for your own requirements. Thermostatic valves offer safe and controllable showering for the entire family. Shower valves and brassware features polished chrome, enhanced by timeless white ceramic, to both look fantastic and be ergonomic to use. Designed using the highest quality materials to achieve yesterday's designs with today's technology, you are ensured a great showering experience.

See pages 158-167 for the full showering range



This page: Eden Thermostatic exposed shower barvalve single outlet with rigid riser and swivel shower arm with 9" rose €701. Shown with hinged door 80cm and in line panel 30cm €748 and Chaplin Radiator €584.

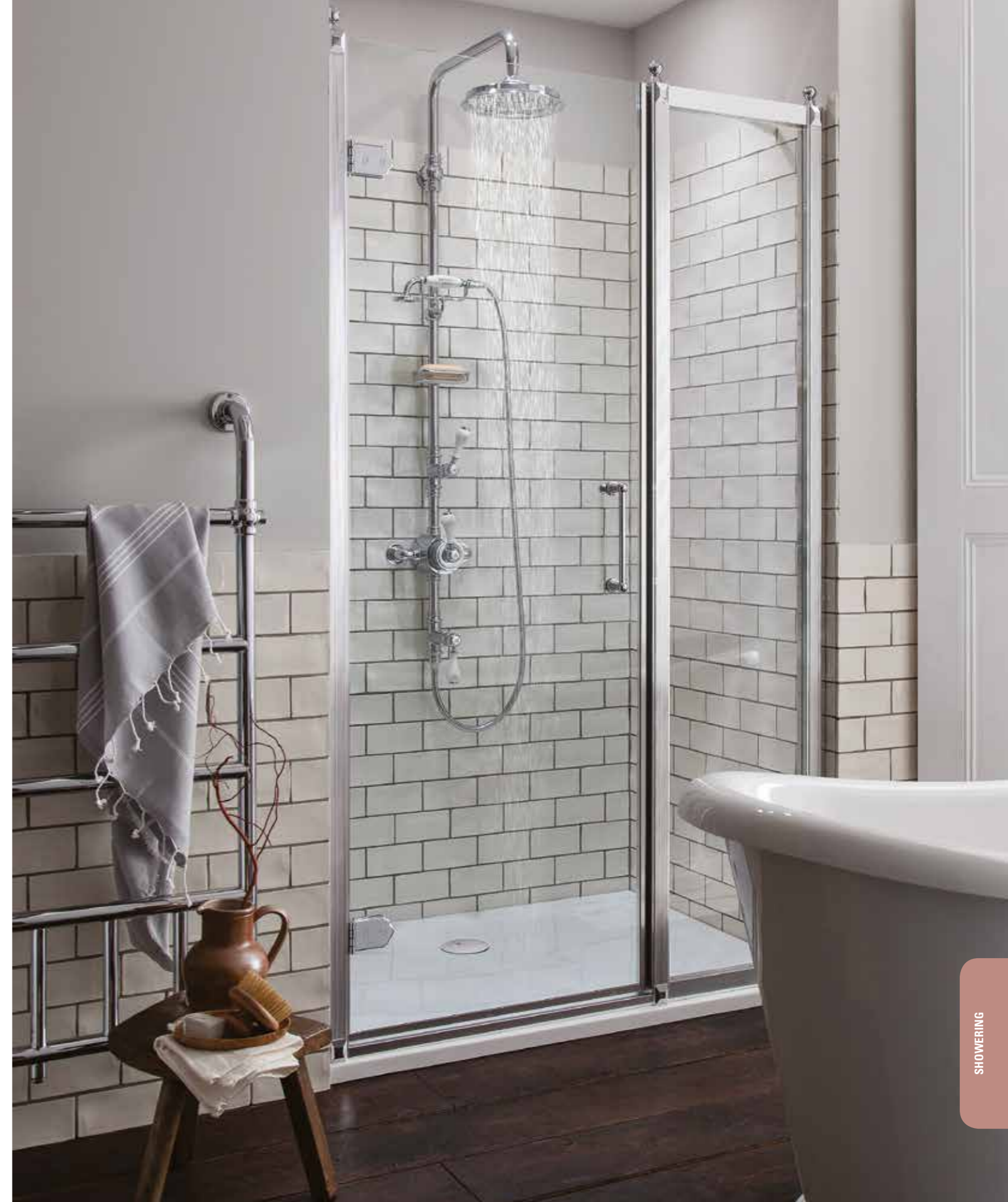

This page: Stour Thermostatic Exposed shower valve two-outlet, rigid riser, fixed shower arm, handset and holder with hose and soap basket and 9" rose €1579. Shown with hinged door 80cm and in line panel 30cm €748 and Chaplin Radiator €584.

See pages 168-175 for the full shower enclosure range.

SHOWERING

SHOWERING



Anti-limescale

You can rub off limescale in an instant
 With Burlington's EasyClean technology you can easily remove limescale.
 Simply rub your fingers over the silicon nipples - and the limescale is removed.
 The nipples also help direct the water in the correct direction, not sideways!
 This results in a clean showerhead, delivering the experience it is designed to do... for years to come.



10 year guarantee

See www.burlingtonbathrooms.com/Home/Guarantee

Water label

The European Water Label (EWL) is a voluntary system by European Manufacturers supported by Burlington and 80 other major brands. The EWL's online database and product labels ensure transparency by clearly marking the water consumption of bathroom products.



One-way-water

All our shower valves have non-return valves built in. A non-return valve is a type of valve that allows the water to flow in one direction but closes automatically to prevent flow in the opposite direction (backflow). Preventing this backflow is important because: it can diminish process heating efficiency; prevents possible siphonage of contaminated water back into the potable water supply; can prevent water hammer (the noise of water in your pipes) and they protect your shower cartridge and thermostat.



AirBurst

More power, less water... Water saving without ruining your shower!

All our fixed shower heads have AirBurst built in

Air is forced into the water flow through a hole in the under-surface of the shower head. Water and air mix, this mixture spins around causing turbulence which increases the pressure inside the shower head. The water passes out of the shower head with the power of a traditional shower - so you do not feel any difference... except you can save up the 33% of water (and save up to 33% in energy costs to heat your shower water!)



Thermostatic safety

Vernet is the world leader in thermostatic shower components, and provide the best possible temperature and safety measures available. The quality materials in the capsule minimise any potential limescale effects on working parts - enabling extended lifetimes of performance. Burlington uses Vernet wax capsules across its range - this means that the temperature of your shower will not vary by more than +/- 1°C - even if someone flushes a WC whilst you are showering!



Ceramic disc technology

Extremes of temperature, the stresses caused by hard water (water rich in lime) and the corrosion caused by chlorine means the ceramic disc and thermostatic cartridges are under daily attack. They are also the most hard working items in the bathroom.

Ceramic discs are harder than diamonds - The hardest material known to man!

Burlington is developing disc valves in Germany and is standardising this technology across its range.

Larger bore shower hoses

All our shower hoses are 11mm bore vs. the standard 8mm bore (the 'bore' is the hollow part inside the shower hose tube).

This allows for an increased water flow (a minimum of 33% more water) - especially important in low water pressure environments.



11mm bore

8mm bore

Trent Concealed Thermostatic Showers



Thermostatic single function brass valve with independent temperature control
 Traditional brass faceplate, Claremont handle, with ceramic lever
 390mm adjustable fixed shower arm
 6" AirBurst shower head

TF1S + V16 **€526**



Thermostatic single function brass valve with independent temperature control
 Traditional brass faceplate, Claremont handle, with ceramic lever
 Slide rail including the elbow, hose and handset with ceramic handle

TF1H **€515**



10 year guarantee



Thermostatic safety

OPTIONS

Upgrade from a 6" head to 9" or 12"



9" AirBurst shower head

V17* **Add €59**



12" AirBurst shower head

V60* **Add €117**



Anglesey
 Anglesey Valve Handle (single)

V2 **Add €24**



Birkenhead
 Birkenhead Valve Handle (single)

V3 **Add €24**

* To upgrade the head, remove the V16 from the product code and add V17 (9" head) or V60 (12" head).

Trent Concealed Thermostatic Showers



Air burst



Anti limescale



Thermostatic dual function brass valve with independent flow diverter and temperature controls.
 Traditional brass faceplate, Claremont handle, with ceramic lever
 Wall outlet, and 1500mm shower hose
 Adjustable wall bracket, and handset with ceramic handle
 390mm adjustable fixed shower arm
 6" AirBurst shower head

TF2S + V16 **€760**

OPTIONS



Slide rail

V33 **Add €53**

Slide rail, cradle, soap basket and alternative valve handles can be ordered as extras.

Note TF1H includes slide rail.



Cradle

V24 **Add €47**



Soap basket

V23 **Add €47**

Upgrade products for the vertical riser



Thermostatic dual function brass valve with 2 independent on/off controls and central temperature control
 Traditional brass faceplate, Claremont handle, with ceramic levers
 Wall outlet, and 1500mm shower hose
 Adjustable wall bracket, and handset with ceramic handle
 390mm adjustable fixed shower arm
 6" AirBurst shower head

TF3S + V16 **€818**

Severn Concealed Thermostatic Showers



OPTIONS

Upgrade from a 6" head to 9" or 12"



9" AirBurst shower head
V17* Add **€59**



12" AirBurst shower head
V60* Add **€117**



Anglesey
Anglesey Valve Handle (single)
V2 Add **€24**



Birkenhead
Birkenhead Valve Handle (single)
V3 Add **€24**

* To upgrade the head, remove the V16 from the product code and add V17 (9" head) or V60 (12" head).

Thermostatic single function brass valve with independent temperature control.
Traditional brass faceplate, Claremont handle, with ceramic lever
390mm adjustable fixed shower arm
6" AirBurst shower head

VF1S + V16 **€526**

Thermostatic dual function brass valve with 2 independent on/off controls and central temperature control
Traditional brass faceplate, Claremont handle, with ceramic levers
Wall outlet, and 1500mm shower hose
Adjustable wall bracket, and handset with ceramic handle
390mm adjustable fixed shower arm
6" AirBurst shower head

VF3S + V16 **€818**

Spey Exposed Thermostatic Showers

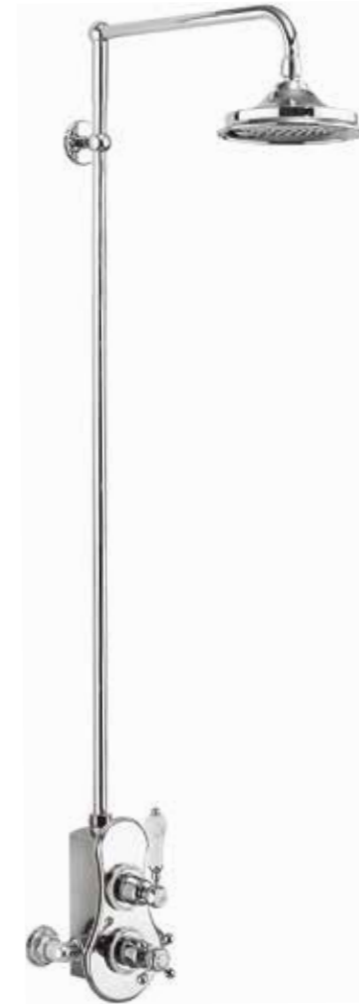

OPTIONS



Slide rail
V33 Add **€53**



Cradle
V24 Add **€47**



Soap basket
V23 Add **€47**

Slide rail, cradle, soap basket and alternative valve handles can be ordered as extras.

Upgrade products for the vertical riser

Thermostatic single function brass valve with independent temperature control
Traditional brass faceplate, Claremont handle, with ceramic lever
18mm diameter vertical brass shower riser
355mm adjustable swivel shower arm
6" AirBurst shower head

BSF1S + V16 **€701**

Thermostatic dual function brass valve with 2 independent on/off controls and central temperature control
Traditional brass faceplate, Claremont handle, with ceramic levers
Adjustable wall bracket, 1500mm shower hose, and handset with ceramic handle
18mm diameter vertical brass shower riser
355mm adjustable swivel shower arm
6" AirBurst shower head

BSF3S + V16 **€935**

Avon Exposed Thermostatic Showers





OPTIONS

Upgrade from a 6" head to 9" or 12"

- 

9" AirBurst shower head
V17* Add **€59**
- 

12" AirBurst shower head
V60* Add **€117**
- 

Anglesey
Anglesey Valve Handle (single)
V2 Add **€24**
- 

Birkenhead
Birkenhead Valve Handle (single)
V3 Add **€24**
- 

Spout Fitting
V32 Add **€70**

* To upgrade the head, remove the V16 from the product code and add V17 (9" head) or V60 (12" head).

Thermostatic single function brass valve with independent temperature control
Traditional brass body, Claremont handle, with ceramic lever
390mm adjustable fixed shower arm
6" AirBurst shower head

AF1S + V16 **€701**

Thermostatic dual function brass valve with 2 independent on/off controls and central temperature control
Traditional brass body, Claremont handle, with ceramic levers
Adjustable wall bracket, 1500mm shower hose, and handset with ceramic handle
18mm diameter vertical brass shower riser
355mm adjustable swivel shower arm
6" AirBurst shower head

BAF3S + V16 **€935**

Tay Bath Shower Thermostatic Mixers

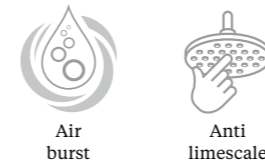

OPTIONS

- 

Slide rail
V33 Add **€53**
- 

Ceramic telephone handset, hose and diverter
V27 Add **€198**
- 

Cradle
V24 Add **€47**
- 

Soap basket
V23 Add **€47**

Slide rail, handset, hose, diverter, cradle, soap basket and alternative valve handles can be ordered as extras.

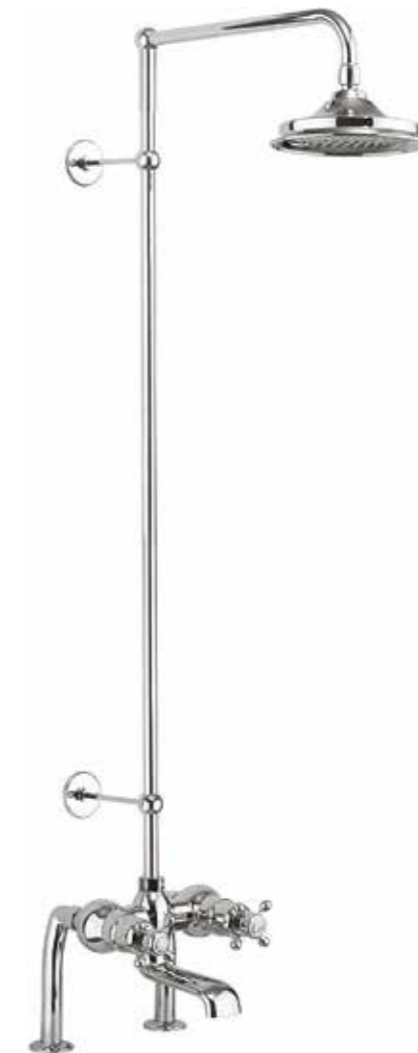

Thermostatic two outlet twin control bath shower mixer valve with independent flow diverter and temperature controls
Traditional brass body, and Claremont handles, with ceramic indices
Brass bath spout with swivel function
Available deck or wall mounted
18mm diameter vertical brass shower riser
355mm adjustable swivel shower arm
6" AirBurst shower head

Deck Mounted BT2DS + V16 **€1286**

Wall mounted BT2WS + V16 **€1169**



Thermostatic two outlet twin control bath shower mixer valve with independent flow diverter and temperature controls
Traditional brass body, and Claremont handles, with ceramic indices
Brass bath spout with swivel function
Available deck or wall mounted
S connector and bracket, 1500mm shower hose, and handset with ceramic handle

Deck Mounted T2DB **€935**

Wall mounted T2WB **€865**

Eden Exposed Thermostatic Showers



Thermostatic single outlet twin control valve with independent on/off flow and temperature controls

Traditional brass body, Claremont handles, with ceramic indices

18mm diameter vertical brass shower riser

355mm adjustable swivel shower arm

6" AirBurst shower head

BEF1S + V16 **€643**

Thermostatic two outlet twin control valve with independent flow divertor and temperature controls

Traditional brass body, and Claremont handles, with ceramic indices

Adjustable wall bracket, 1500mm shower hose, and handset with ceramic handle

18mm diameter vertical brass shower riser 355mm adjustable swivel shower arm

6" AirBurst shower head

BEF2S + V16 **€877**



OPTIONS

Upgrade from a 6" head to 9" or 12"



9" AirBurst shower head

V17* **Add €59**



12" AirBurst shower head

V60* **Add €117**

Upgrade products for the vertical riser



Cradle

V24 **Add €47**



Soap basket

V23 **Add €47**



Slide rail

V33 **Add €53**



Anglesey
Anglesey Valve
Handle (single)

V2 **Add €24**



Birkenhead
Birkenhead Valve
Handle (single)

V3 **Add €24**

* To upgrade the head, remove the V16 from the product code and add V17 (9" head) or V60 (12" head).

Slide rail, cradle, soap basket and alternative valve handles can be ordered as extras. Remember if your chosen shower has 2 valve handles and you are changing to Anglesey or Birkenhead, you will need 2 valve handles

Stour Exposed Thermostatic Showers



Thermostatic single function brass valve with independent temperature control
 Traditional brass body, ceramic handle, with ceramic levers
 Fixed cradle, 1500mm shower hose, and handset with ceramic handle
 28mm diameter, 450mm adjustable fixed shower arm
 6" AirBurst shower head

BF1S + V16 **£1169**

Thermostatic single function brass valve with independent temperature control
 Traditional brass body, ceramic handle, with ceramic levers
 28mm diameter vertical brass shower riser
 450mm adjustable fixed shower arm
 Soap basket
 6" AirBurst shower head

BF2S + V16 **£1286**

Thermostatic dual function brass valve with 2 independent on/off controls and central temperature control
 Traditional brass body, ceramic handle, with ceramic levers
 Fixed cradle, 1500mm shower hose, and handset with ceramic handle
 28mm diameter vertical brass shower riser
 450mm adjustable fixed shower arm
 Soap basket
 6" AirBurst shower head

BF3S + V16 **£1520**

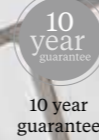

OPTIONS

Upgrade from a 6" head to 9" or 12"



9" AirBurst shower head

V17*



12" AirBurst shower head

V60*

Add £59

Add £117

Hinged Doors



A: Hinged Door

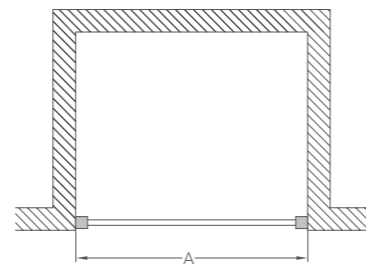

*This indicates depth of matching tray size available for use in a recessed installation. All enclosures are 1950 high and adjustable up to 20mm from each wall.

All shower posts are constructed from aluminium and can be installed with or without chrome ball header. Safety glass is 8mm thick and 3M™ easy clean coating.

Shower tray prices exclude waste

Z1205	€24
-------	------------

Size*	Adjustment min-max	Enclosure Code	Enclosure Price	Tray Code	Tray Price
76 x 76	72-76	BU1 (C19)	€467	Z1159	€106
80 x 80	76-80	BU2 (C20)	€514	Z1160	€119
90 x 76	86-90	BU3 (C21)	€561	Z1163	€195
90 x 80	86-90	BU3 (C21)	€561	Z1164	€203
90 x 90	86-90	BU3 (C21)	€561	Z1161	€184
90 x 120	86-90	BU3 (C21)	€561	Z1176	€184

Hinged Doors & Side Panels



On all showers
See website for details



A: Hinged Door
C: Side panel

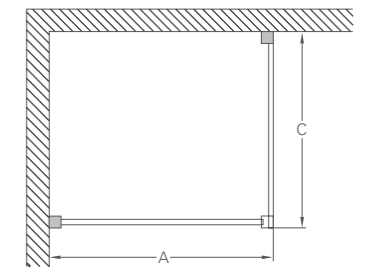

*All enclosures are 1950 high and adjustable up to 20mm from each wall.

All shower posts are constructed from aluminium and can be installed with or without chrome ball header. Safety glass is 8mm thick and 3M™ easy clean coating.

Shower tray prices exclude waste

Z1205	€24
-------	------------

Size*	Adjustment min-max	Enclosure Code	Enclosure Price	Tray Code	Tray Price
76 x 76	73-75	BU11 (C19+C12)	€807	Z1159	€106
76 x 90	73-75, 87-89	BU12 (C19+C14)	€853	Z1163	€195
80 x 80	77-79	BU13 (C20+C13)	€877	Z1160	€119
80 x 90	77-79, 87-89	BU14 (C20+C14)	€900	Z1164	€203
90 x 76	87-89, 73-75	BU15 (C21+C12)	€900	Z1163	€195
90 x 80	87-89, 77-79	BU16 (C21+C13)	€724	Z1164	€203
90 x 90	87-89	BU17 (C21+C14)	€947	Z1161	€184

Hinged Doors with In-line Panels



A: Hinged door
B: In-line panel

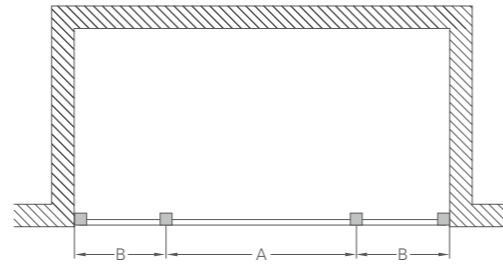

Size	Adjustment min-max	Enclosure Code	Enclosure Price	Tray Code	Tray Price
1000 x 700	960-1000	BU4 (C20+C15)	£713	Z1165	£198
1000 x 760	960-1000	BU4 (C20+C15)	£713	Z1166	£203
1000 x 800	960-1000	BU4 (C20+C15)	£713	Z1167	£210
1000 x 900	960-1000	BU4 (C20+C15)	£713	Z1168	£209
1000 x 1000	960-1000	BU4 (C20+C15)	£713	Z1162	£258
1100 x 700	1060-1100	BU5 (C20+C16)	£748	Z1169	£243
1100 x 760	1060-1100	BU5 (C20+C16)	£748	Z1170	£224
1100 x 800	1060-1100	BU5 (C20+C16)	£748	Z1171	£224
1100 x 900	1060-1100	BU5 (C20+C16)	£748	Z1172	£224
1200 x 700	1160-1200	BU6 (C20+C17)	£807	Z1173	£219
1200 x 760	1160-1200	BU6 (C20+C17)	£807	Z1174	£219
1200 x 800	1160-1200	BU6 (C20+C17)	£807	Z1175	£219
1200 x 900	1160-1200	BU6 (C20+C17)	£807	Z1176	£243
1400 x 800	1360-1400	BU7 (C20+C16+C16)	£982	Z1177	£327
1400 x 900	1360-1400	BU7 (C20+C16+C16)	£982	Z1178	£327
1500 x 700	1460-1500	BU8 (C21+C16+C16)	£1029	Z1179	£332
1500 x 760	1460-1500	BU8 (C21+C16+C16)	£1029	Z1180	£349
1500 x 800	1460-1500	BU8 (C21+C16+C16)	£1029	Z1181	£419
1600 x 700	1560-1600	BU9 (C20+C17+C17)	£1099	Z1182	£404
1700 x 700	1660-1700	BU10 (C21+C17+C17)	£1146	Z1183	£422
1700 x 760	1660-1700	BU10 (C21+C17+C17)	£1146	Z1184	£422
1700 x 800	1660-1700	BU10 (C21+C17+C17)	£1146	Z1185	£492

*This indicates depth of matching tray size available for use in a recessed installation. All enclosures are 1950 high and adjustable up to 20mm from each wall.

All shower posts are constructed from aluminium and can be installed with or without chrome ball header. Safety glass is 8mm thick and 3M™ easy clean coating.

Shower tray prices exclude waste
Z1205 **£24**

Hinged Doors with In-line & Side Panels



On all showers
See website for details



A: Hinged door
B: In-line panel
C: Side panel

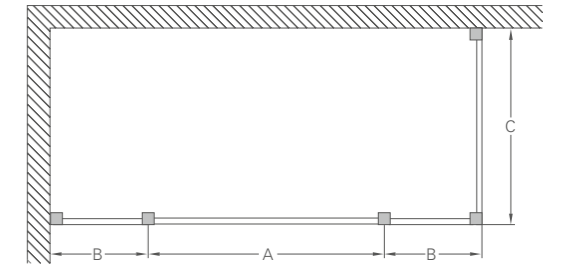

Size*	Adjustment min-max	Enclosure Code	Enclosure Price	Tray Code	Tray Price
1000 x 700	970-990, 670-690	BU18 (C20+C15+C11)	£1041	Z1165	£198
1000 x 760	970-990, 730-750	BU19 (C20+C15+C12)	£1052	Z1166	£203
1000 x 800	970-990, 770-790	BU20 (C20+C15+C13)	£1076	Z1167	£210
1000 x 900	970-990, 870-890	BU21 (C20+C15+C14)	£1099	Z1168	£209
1100 x 700	1070-1090, 670-690	BU22 (C20+C16+C11)	£1076	Z1169	£243
1100 x 760	1070-1090, 730-750	BU23 (C20+C16+C12)	£1087	Z1170	£224
1100 x 800	1070-1090, 770-790	BU24 (C20+C16+C13)	£1111	Z1171	£224
1100 x 900	1070-1090, 870-890	BU25 (C20+C16+C14)	£1134	Z1172	£224
1200 x 700	1170-1190, 670-690	BU26 (C21+C16+C11)	£1123	Z1173	£219
1200 x 760	1170-1190, 730-750	BU27 (C20+C17+C12)	£1134	Z1174	£219
1200 x 800	1170-1190, 770-790	BU28 (C20+C17+C13)	£1158	Z1175	£219
1200 x 900	1170-1190, 870-890	BU29 (C20+C17+C14)	£1181	Z1176	£243
1400 x 800	1370-1390, 770-790	BU30 (C20+C16+C16+C13)	£1345	Z1177	£327
1400 x 900	1370-1390, 870-890	BU31 (C20+C16+C16+C14)	£1368	Z1178	£327
1500 x 700	1470-1490, 670-690	BU32 (C21+C16+C16+C11)	£1357	Z1179	£332
1500 x 760	1470-1490, 730-750	BU33 (C21+C16+C16+C12)	£1368	Z1180	£349
1500 x 800	1470-1490, 770-790	BU34 (C21+C16+C16+C13)	£1392	Z1181	£419
1600 x 700	1570-1590, 670-690	BU35 (C20+C17+C17+C11)	£1415	Z1182	£404
1700 x 700	1670-1690, 670-690	BU36 (C21+C17+C17+C11)	£1474	Z1183	£422
1700 x 760	1670-1690, 730-750	BU37 (C21+C17+C17+C12)	£1485	Z1184	£422
1700 x 800	1670-1690, 770-790	BU38 (C21+C17+C17+C13)	£1509	Z1185	£492

*All enclosures are 1950 high and adjustable up to 20mm from each wall.

All shower posts are constructed from aluminium and can be installed with or without chrome ball header. Safety glass is 8mm thick and 3M™ easy clean coating.

Shower tray prices exclude waste
Z1205 **£24**

Quadrants



D: Quadrant

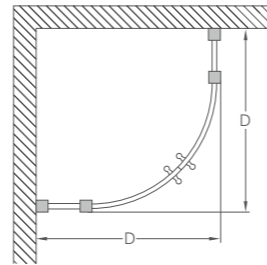

Size	Adjustment min-max	Enclosure Code	Enclosure Price	Tray Code	Tray Price
80 x 80	77-79	BU39 (C22)	€795	Z1192	€177
90 x 90	87-89	BU40 (C23)	€818	Z1193	€217

*All enclosures are 1950 high and adjustable up to 20mm from each wall.

All shower posts are constructed from aluminium and can be installed with or without chrome ball header. Safety glass is 8mm thick and 3M™ easy clean coating.

Shower tray prices exclude waste
Z1205 **€24**

Offset Quadrants



On all showers
See website for details



D: Quadrant
B: In-line panel

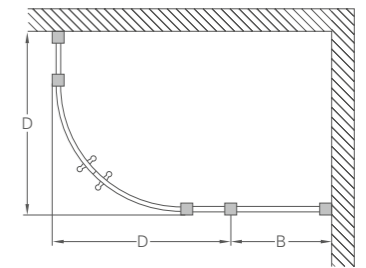

Left hand quadrant

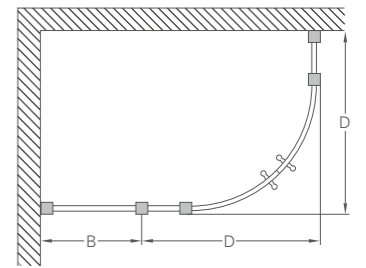

Right hand quadrant

Size	Enclosure	Adjustment min-max	Enclosure Code	Enclosure Price	Tray Code	Tray Price
80 x 100	Left hand	770-790, 970-990	BU41 (C22+C15)	€994	Z1199	€274
80 x 100	Right hand	770-790, 970-990	BU41 (C22+C15)	€994	Z1200	€274
80 x 120	Left hand	770-790, 1170-1190	BU91 (C22+C17)	€1087	Z1201	€302
80 x 120	Right hand	770-790, 1170-1190	BU91 (C22+C17)	€1087	Z1202	€302
90 x 120	Left hand	870-890, 1170-1190	BU42 (C23+C16)	€1052	Z1203	€314
90 x 120	Right hand	870-890, 1170-1190	BU42 (C23+C16)	€1052	Z1204	€314

*All enclosures are 1950 high and adjustable up to 20mm from each wall.

All shower posts are constructed from aluminium and can be installed with or without chrome ball header. Safety glass is 8mm thick and 3M™ easy clean coating.

Shower tray prices exclude waste
Z1205 **€24**

Sliding Doors



A: Slider
B: In-line panel

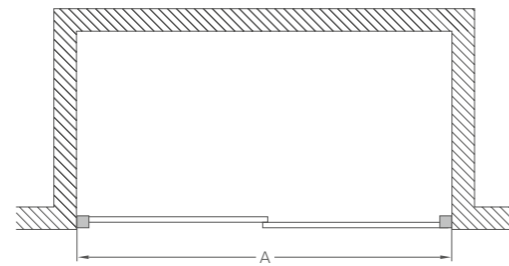

Sliding door

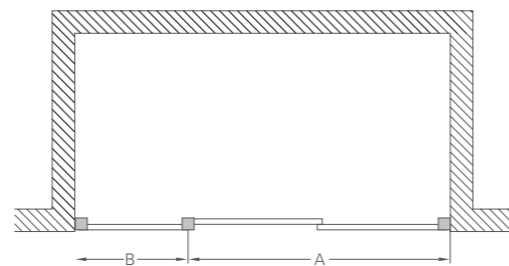

Sliding door with in-line panel

Soft-close sliding door

Size	Adjustment min-max	Enclosure Code	Enclosure Price	Tray Code	Tray Price
1100 x 700	1070-1090	BU68 (C6S)	£701	Z1169	£243
1100 x 760	1070-1090	BU68 (C6S)	£701	Z1170	£224
1100 x 800	1070-1090	BU68 (C6S)	£701	Z1171	£224
1100 x 900	1070-1090	BU68 (C6S)	£701	Z1172	£224
1200 x 700	1170-1190	BU69 (C7S)	£760	Z1173	£219
1200 x 760	1170-1190	BU69 (C7S)	£760	Z1174	£219
1200 x 800	1170-1190	BU69 (C7S)	£760	Z1175	£219
1200 x 900	1170-1190	BU69 (C7S)	£760	Z1176	£243
1400 x 800	1370-1390	BU70 (C8S)	£877	Z1177	£327
1400 x 900	1370-1390	BU70 (C8S)	£877	Z1178	£327

*This indicates depth of matching tray size available for use in a recessed installation. All enclosures are 1950 high and adjustable up to 20mm from each wall.

All shower posts are constructed from aluminium and can be installed with or without chrome ball header. Safety glass is 8mm thick and 3M™ easy clean coating.

Soft-close mechanisms are supplied with the door and can be fitted as an option.

Shower tray prices exclude waste

Z1205 **£24**



Soft-close sliding door with in-line panel

Size	Adjustment min-max	Enclosure Code	Enclosure Price	Tray Code	Tray Price
1500 x 700	1470-1490	BU71 (C7S+C16)	£994	Z1179	£332
1500 x 760	1470-1490	BU71 (C7S+C16)	£994	Z1180	£349
1500 x 800	1470-1490	BU71 (C7S+C16)	£994	Z1181	£419
1600 x 700	1570-1590	BU72 (C8S+C15)	£1076	Z1182	£404
1700 x 700	1670-1690	BU73 (C8S+C16)	£1111	Z1183	£422
1700 x 760	1670-1690	BU73 (C8S+C16)	£1111	Z1184	£422
1700 x 800	1670-1690	BU73 (C8S+C16)	£1111	Z1185	£492

Sliding Doors with Side Panels



On all showers
See website for details



A: Slider
B: In-line panel
C: Side panel

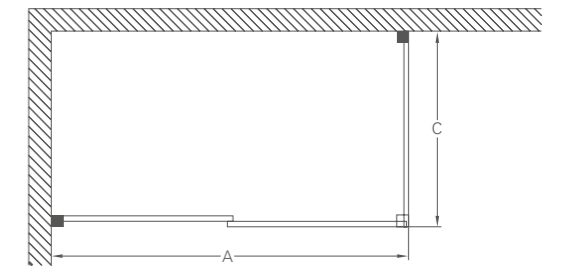

Sliding door with side panel

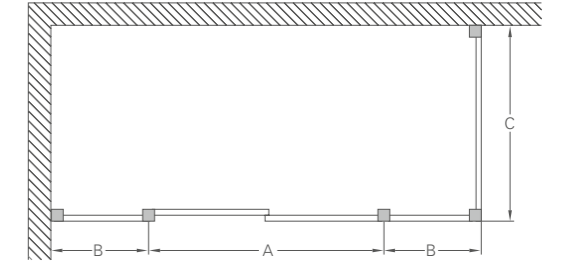

Sliding door with in-line and side panel

Soft-close sliding door with side panel

Size*	Adjustment min-max	Enclosure Code	Enclosure Price	Tray Code	Tray Price
1100 x 700	1070-1090, 670-690	BU74 (C6S+C11)	£1029	Z1169	£243
1100 x 760	1070-1090, 730-750	BU75 (C6S+C12)	£1041	Z1170	£224
1100 x 800	1070-1090, 770-790	BU76 (C6S+C13)	£1064	Z1171	£224
1100 x 900	1070-1090, 870-890	BU77 (C6S+C14)	£1087	Z1172	£224
1200 x 700	1170-1190, 670-690	BU78 (C7S+C11)	£1087	Z1173	£219
1200 x 760	1170-1190, 730-750	BU79 (C7S+C12)	£1099	Z1174	£219
1200 x 800	1170-1190, 770-790	BU80 (C7S+C13)	£1123	Z1175	£219
1200 x 900	1170-1190, 870-890	BU81 (C7S+C14)	£1146	Z1176	£243
1400 x 800	1370-1390, 770-790	BU82 (C8S+C13)	£1240	Z1177	£327
1400 x 900	1370-1390, 870-890	BU83 (C8S+C14)	£1263	Z1178	£327

*All enclosures are 1950 high and adjustable up to 20mm from each wall.

All shower posts are constructed from aluminium and can be installed with or without chrome ball header. Safety glass is 8mm thick and 3M™ easy clean coating.

Soft-close mechanisms are supplied with the door and can be fitted as an option.

Shower tray prices exclude waste

Z1205 **£24**



Soft-close sliding door with in-line and side panel

Size*	Adjustment min-max	Enclosure Code	Enclosure Price	Tray Code	Tray Price
1500 x 700	1470-1490, 670-690	BU84 (C7S+C16+C11)	£1321	Z1179	£332
1500 x 760	1470-1490, 730-750	BU85 (C7S+C16+C12)	£1333	Z1180	£349
1500 x 800	1470-1490, 770-790	BU86 (C7S+C16+C13)	£1357	Z1181	£419
1600 x 700	1570-1590, 670-690	BU87 (C8S+C15+C11)	£1403	Z1182	£404
1700 x 700	1670-1690, 670-690	BU88 (C8S+C16+C11)	£1438	Z1183	£422
1700 x 760	1670-1690, 730-750	BU89 (C8S+C16+C12)	£1450	Z1184	£422
1700 x 800	1670-1690, 770-790	BU90 (C8S+C16+C13)	£1474	Z1185	£492

Radiators

Burlington radiators offer a broad range of various styles. There are options here to complement your traditional bathroom beautifully. All Burlington radiators except the Strand, are designed to work with the extra fitting of an electric summer heating kit, allowing you to have warm towels all year round.

See pages 178-179 for the full range of radiators

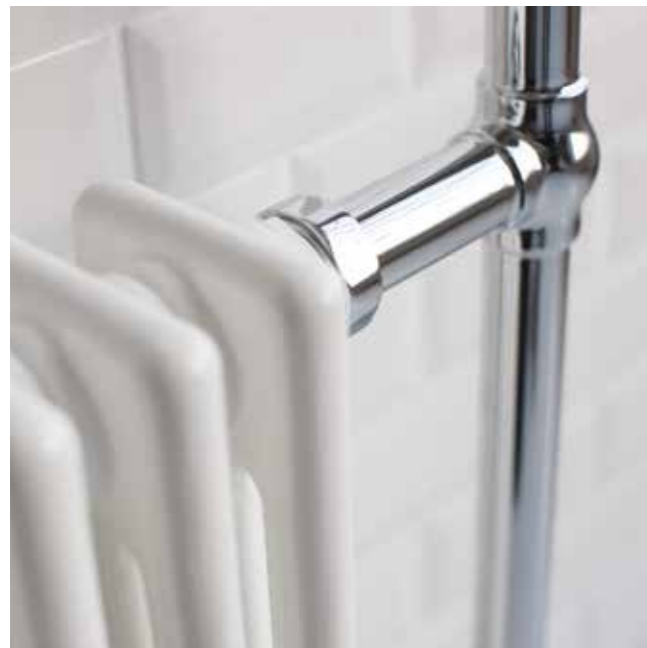

Radiators



Chaplin radiator
(shown with angled valves)
D: 13, W: 54, H: 114
R12 CHR

€584



Trafalgar radiator
(shown with angled valves)
D: 24, W: 64, H: 95
R1 CHR

€584



Bloomsbury radiator
(shown with angled valves)
D: 24, W: 50, H: 95
R2 CHR

€467

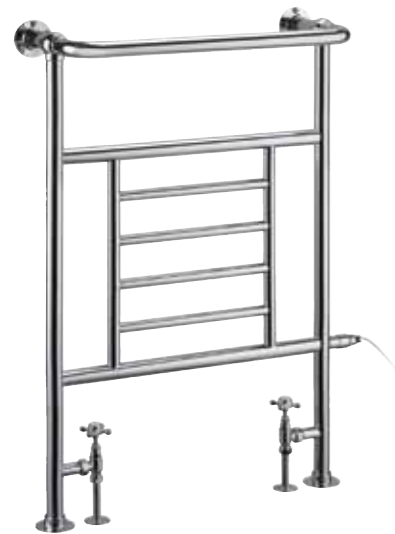

Vincent radiator
(shown with angled valves)
D: 24, W: 64, H: 95
R5 CHR

€526



Berkeley radiator
(shown with angled valves)
D: 24, W: 64, H: 95
R4 CHR

€350



Clever radiator
(shown with angled valves)
D: 24, W: 64, H: 72
R3 CHR

€350



Strand radiator
(shown with angled valves)
D: 39, W: 64, H: 40
R11 CHR

€409



400W Summer electric heating
Kit for Trafalgar
R10 CHR

€140

250W Summer electric heating
kit for Bloomsbury and Vincent
R9 CHR

€128

150W Summer electric heating
kit for Chaplin, Cleaver, Berkeley
R8 CHR

€116

Electric Summer Heating Kits

All our radiators except R11CHR have been designed to allow for the fitting of an electric summer heating kit. This means that you can have warm towel rails all year round! Our radiators contain steel and are therefore only suitable for hot water (closed) central heating systems.

During electric heating use the valves must be left open so the radiator is full of water to ensure correct performance.

All Electric heating kits are rated IP44.



Straight radiator valves
D: 10, W: 9, H: 24
R7 CHR

€58



Angled radiator valves
D: 7, W: 9, H: 24
R6 CHR

€58

Radiator British Thermal Units (BTUs)

The heat outputs of our radiators connected to your central heating system:

	ΔT=50°C Watts	ΔT=55°C Watts	ΔT=60°C Watts	BTU's
Trafalgar	558	623	688	2346
Bloomsbury	387	430	473	1613
Vincent	206	227	246	839
Berkeley	238	263	289	985
Cleaver	266	294	323	1101
Strand	153	174	196	669
Chaplin	320	372	408	1392

All radiator outputs are tested to EN442

Mirrors & Lights

The perfect addition to your bathroom, Burlington mirrors add intricate detail and increase the period feel of your bathroom. Choose between the simplistic and pared back rectangular or arched mirrors, or the detailed and beautiful Georgian style mirrors available in polished black or white aluminium. In addition to the classic Edwardian lights either in round or elliptical style, Burlington have increased their range of lighting options, giving you various possibilities. Choose your base style in beautiful chrome and compliment with a fabric shade or a glass cup. These pieces are sure to give that extra finishing touch to your vintage look.

See pages 182-185 for the full range of mirrors and lights



Mirrors



Polished aluminium frame mirror
D: 4, W: 55, H: 75
T37 ALU €350



Black aluminium frame mirror
D: 4, W: 55, H: 75
T47 BLA €350



White aluminium frame mirror
D: 4, W: 55, H: 75
T42 WHI €350



Arched mirror
D: 3, W: 50, H: 70
A9 €233



Rectangular mirror
D: 3, W: 50, H: 70
A11 €233



Curved mirror
D: 3, W: 70, H: 70
A38 €268

All mirrors are sealed with Gunther Seal-Kwik. This ensures that the mirrors aren't affected by 'black-edge' - the oxidisation of the mirrors edge that occurs in moist environments.

For mirrors that match Burlington furniture see page 95

Lights



Burlington round light with chrome base and cup frosted glass shade
D: 19, W: 17, H: 22
BL11 €205



Burlington round light with chrome base and vase clear glass shade
D: 17, W: 12, H: 30
BL14 €205



Burlington round light with chrome base and tube frosted glass shade
D: 15, W: 12, H: 30
BL13 €205



Burlington round light with chrome base and fine pleated shade in white
D: 18, W: 15, H: 23
BL12 €205



Burlington round light with chrome base and chiffon silver shade
D: 17, W: 16, H: 33
BL15 €205



Edwardian single round LED light
With pull cord
D: 17, W: 16, H: 25
T50 €105



Edwardian single elliptical LED light
With pull cord
D: 15, W: 11, H: 24
T52 €105

Our T50 and T52 Edwardian single elliptical lights will now include LED lighting as standard

Technical Information

Our Burlington ornate lights are supplied with G9 light bulbs. They are 28 watts, but give 40 watts of light and have an IP rating of IP44.

Ornate Lights



Burlington ornate light with chrome base and cup frosted glass shade
D: 23, W: 17, H: 28
BL21 €205



Burlington ornate light with chrome base and vase clear glass shade
D: 20, W: 12, H: 36
BL24 €205



Burlington ornate light with chrome base and tube frosted glass shade
D: 18, W: 12, H: 36
BL23 €205



Burlington ornate light with chrome base and fine pleated shade in white
D: 21, W: 15, H: 29
BL22 €205



Burlington ornate light with chrome base and chiffon silver shade
D: 21, W: 16, H: 29
BL25 €205

Technical Information

Our Burlington ornate lights are supplied with G9 light bulbs. They are 28 watts, but give 40 watts of light and have an IP rating of IP44.

Accessories

Our range of accessories will provide the finishing touches to ensure your bathroom looks and functions perfectly. From classically styled chrome soap dishes, to ceramic toothbrush holders, every item is traditionally crafted in chrome plated solid brass, to guarantee the balance of functionality and style.



Accessories



Soap Dish
D: 15, W: 16, H: 6
A1 CHR **€41**



Tumbler Holder
Chrome
D: 12, W: 8, H: 11
A2 CHR **€40**



Single Soap Dispenser
D: 14, W: 8, H: 21
A19 CHR **€105**



Double Soap Dispenser
D: 13, W: 19, H: 21
A20 CHR **€140**



Surface mounted soap dispenser
Chrome (can be mounted through a ceramic basin tap hole or a work surface)
L: 11cm, W: 7cm, D: 7cm
A48 CHR **€105**



Accessory Back Plate
D: 6, W: 3, H: 6
G13 **€13**



Medium Ornate Bracket
D: 2, W: 23, H: 16
T32 CHR **€70**

Accessories Information

All accessories are plated with 12-15µm nickel and 0.3-0.4µm chrome. This compares to industry norms of 5-7µm nickel and 0.15-0.25µm chrome. This results in a deeper and more durable chrome finish.

All accessories are supplied with extra chrome plated domed head screws.

All accessories have 'screw-through' (patent pending) design to ensure no lateral movement.



See website for details



WC Roll Holder
D: 18, W: 8, H: 12
A5 CHR **€70**



WC Roll Holder
Without cover
D: 18, W: 10, H: 10
A16 CHR **€70**



Spire WC Roll Holder
D: 6, W: 17, H: 25
A45 CHR **€128**



Spare WC Roll Holder
D: 6, W: 12, H: 18
A6 CHR **€43**



WC Brush Holder
D: 15, W: 10, H: 43
A8 CHR **€70**



Robe Hook
D: 6, W: 6, H: 6
A14 CHR **€32**



Double Robe Hook
D: 11, W: 6, H: 12
A4 CHR **€43**



Triple Robe Hook
D: 7, W: 10, H: 9
A47 CHR **€53**



Towel Ring
D: 6, W: 17, H: 20
A3 CHR **€43**

Shelf & Racks



Glass Shelf With Railing
D: 16, W: 53, H: 6
A18 CHR

€128



Brass Extendable Bath Rack
D: 21, W: 59-90, H: 9
A27 CHR

€116



Towel Rack
D: 32, W: 66, H: 14
A46 CHR

€257

Wire Baskets

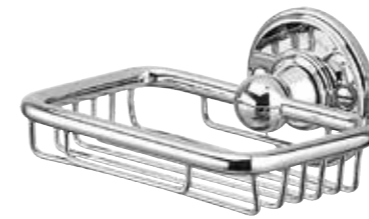

Soap Basket
D: 12, W: 14, H: 6
A13 CHR

€46



Sponge Basket
D: 18, W: 22, H: 6
A15 CHR

€70



Wire Basket
62mm deep
D: 16, W: 33, H: 9
A23 CHR

€116



Corner Basket
36mm deep
D: 22, W: 22, H: 6
Code: A21 CHR

€99



Corner Basket
62mm deep
D: 28, W: 28, H: 9
A22 CHR

€116



Burlington bath basket
D: 24, W: 29, H: 11
A50 CHR

€116



Burlington bath basket shown on a roll top bath

Towel Rails

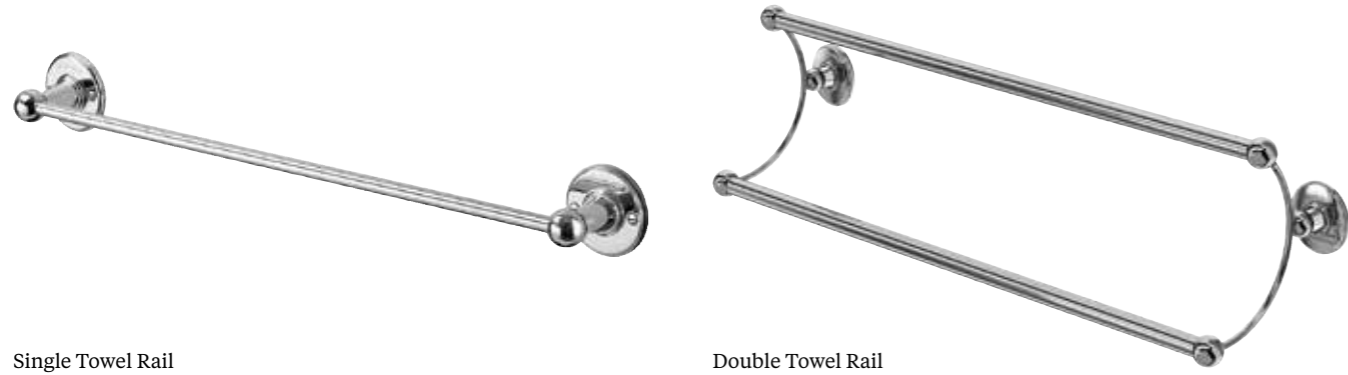

Single Towel Rail
D: 6, W: 55, H: 6
A7 CHR

£53

Double Towel Rail
D: 15, W: 66, H: 17
A17 CHR

£163



For towel rails that fit under your basins see pages 30, 32, 35, 37, 39, 41 and 43.

Towel Ring



Towel Ring
D: 6, W: 17, H: 20
A3 CHR

£43



See website for details



burlingtonbathrooms.com
info@bathroombrands.com
Tel +44(0)1322 473222

Join us on social:
facebook.com/burlingtonbathrooms
twitter.com/burlingtonbaths
pinterest.com/burlingtonbaths



bathroombrands.com

The Bathroom Brands Group
BBL House
Jubilee Promenade
Albert Pier
St Helier
Jersey
JE2 3NW

Due to continuous product improvements we reserve the right to change the product specification without prior notice. The text, images and layout of this catalogue are protected by copyright and other intellectual property rights. All images within this brochure are, where possible, a true representation of our products. Some colours may vary. Please visit the website for more information.

Our website should be used as reference for the most up to date product specification.